

OLP-EC-PV650_P500_E1205-AO01

户外集装箱储能系统用户手册

Outdoor Container Energy Storage System User Manual



欧力普能源与自动化技术有限公司
OLiPower Energy & Automation Technology Co.Ltd

OLP EC-PV650_P500_E1205-AO01 户外集装箱储能系统用户手册	文件编号: OLPSID-MU-25061601 Document number: OLPSID-MU-25061601	版本:V1.1 Version:V1.1	Page 1 of 106
©欧力普能源与自动化技术有限公司 2025 保留所有权利 © Olipower Energy & Automation Technologies 2025 All rights reserved.	地址: 深圳市光明区凤凰街道塘尾社区光明大道 380 号尚智科技园 2 栋 A 座 10 楼 Address: 10th Floor, Block A, Building 2, Shangzhi Science and Technology Park, No. 380 Guangming Avenue, Tangwei Community, Fenghuang Street, Guangming District, Shenzhen, China.		Tel: +86 (755) 2650 8686 Website: www.olipower.cn

文档审批 Document approval

	姓名 Name	部门 Dep	日期 Date	签字 Signature
批准 Approval	贺刚 He Gang	OLP-SID	2025-11-13	Sgd. 贺刚 He Gang
核稿 Check	冬牧 Dong Mu	OLP-SID	2025-11-02	Sgd. 冬牧 Dong Mu
拟稿 Draft	张渊 Zhang Yuan	OLP-SID	2025-06-16	Sgd. 张渊 Zhang Yuan

版本更新记录 Version Update Record

日期 Date	版本 Version	更新说明 Update Description	作者 Author
2025.06.16	V0.1	初版 First edition	张渊 Zhang Yuan
2025.07.16	V1.0	内容更新 Content update	张渊 Zhang Yuan
2025.11.30	V1.1	内容更新 Content update	张渊 Zhang Yuan

OLP EC-PV650_P500_E1205-AO01 户外集装箱储能系统用户手册	文件编号: OLPSID-MU-25061601 Document number: OLPSID-MU-25061601	版本:V1.1 Version:V1.1	Page 2 of 106
---	---	-------------------------	---------------

目录 Content

1. 缩略语 Abbreviations	6
2. 安全注意事项 Safety Precautions	7
2.1. 安全公告 Safety Notice	7
2.1.1. 使用公告 Usage Notice	7
2.1.2. 静电保护 Static Protection	9
2.1.3. 接地要求 Grounding Requirements	9
2.1.4. 防潮保护 Moisture Protection	9
2.1.5. 安全警告标签设置 Security Warning Label Setting	10
2.1.6. 设备运行中的测量 Measurement During Operation	10
2.2. 操作员要求 Operator Requirements	10
2.3. 运行环境要求 Operating Environment Requirements	11
3. 产品技术规格 Product Technical Specification	12
3.1. 产品型号 Product Model	12
3.2. 产品铭牌 Product Nameplate	12
3.3. 产品规格 Product Specifications	13
3.4. 应用场景 Application scenarios	15
3.5. 系统运行模式 System operation mode	16
3.6. 系统原理图 System Schematic Diagram	20
3.7. 产品外观 Product Appearance	22
3.7.1. 外观和尺寸 Appearance and Dimensions	22
3.7.2. 显示面板 Display Panel	23
3.8. 部件说明 Component Description	24
3.8.1. 储能系统 Energy Storage System	26
3.8.2. 储能变流器 (PCS) Power Conversion System (PCS)	34
3.8.3. MPPT	49
3.8.4. 能量管理系统 EMS	50
3.8.5. 热管理系统 Thermal Management System	81
3.8.6. 消防系统 Fire Protection System	83
3.8.7. 水浸系统 Water immersion system	84
3.8.8. 门禁系统 Access Control System	85
4. 安装 Installation	85
4.1. 安装准备 Installation Preparation	85
4.1.1. 安装工具 Installation Tools	85
4.1.2. 安装环境 Installation Environment	86
4.2. 搬运 Handling	86
4.2.1. 重心 Center Of Gravity	88
4.2.2. 搬运方式 Handling Method	88
4.3. 开箱检查 Open Box Inspection	89
4.4. 安装 Installation	90
4.4.1. 安装间隙 Installation clearance	91

Olp EC-PV650_P500_E1205-AO01 户外集装箱储能系统用户手册	文件编号: OLPSID-MU-25061601 Document number: OLPSID-MU-25061601	版本:V1.1 Version:V1.1	Page 3 of 106
---	---	-------------------------	---------------

4.4.2. 安装孔位 Installation Hole Position	92
4.4.3. 地基与勾线 Foundation And Hook Line	92
4.4.4. 固定 Fixing	94
4.5. 电气安装 Electrical Installation	95
4.5.1. 接线检查 Wiring Inspection	95
4.5.2. 接线说明 Wiring Instructions	96
5. 调试与运行 Debugging And Operation	97
5.1. 检查 Inspection	97
5.2. 操作说明 Operating Instructions	98
5.2.1. 开机 Startup	98
5.2.2. 关机 Shutdown	100
6. 故障处理 Fault Handling	101
6.1. 故障一览表 Fault List	101
7. 日常保养与维护 Daily Maintenance	103
7.1. 日常检查项目 Daily Inspection Items	104
7.2. 定期检查项目 Regular Inspection Items	104
8. 设备清单 Equipment List	105
8.1. 设备清单 Equipment list inside container	105
8.2. 配件清单 Accessories List	106

版权所有 © 欧力普能源与自动化技术有限公司 2025，保留一切权利。

未经本公司事先书面许可，任何单位和个人不得以任何形式（包括电子、机械、影印、录制或其他方式）复制、传播本文件的任何部分，或将其存储于检索系统中。

重要提示

您所购买的产品、服务及相关特性均受欧力普公司与您签订的商业合同及条款的约束。本文件中描述的部分产品或功能可能未包含在您的购买或使用范围之内，具体以合同约定为准。

欧力普公司在本文件中所提供的信息仅用于参考目的。由于产品版本更新或其它原因，本文件内容如有变更，恕不另行通知。除非双方另有明确合同约定，欧力普公司不对本文件内容做出任何明示或暗示的声明或保证，包括但不限于适销性、适用于特定目的或不侵权的保证。

本文件中的所有陈述、信息和建议也不构成任何形式的担保或承诺。

Copyright © 2025 Oulip Energy and Automation Technology Co., Ltd. All rights reserved.

Without the prior written permission of our company, no unit or individual may reproduce, disseminate, or store any part of this document in a retrieval system in any form (including electronic, mechanical, photocopying, recording, or other means).

Important Notice

The products, services, and related features you have purchased are subject to the commercial contract and terms signed between you and Oulipu Company. Some products or features described in this document may not be included in your purchase or usage scope, and the specifics shall be subject to the contract agreement.

The information provided by Oulipu Company in this document is for reference purposes only. Due to product version updates or other reasons, the content of this document may change without notice.

Unless otherwise expressly agreed upon in a contract between both parties, Oulipu Company makes no express or implied representations or warranties regarding the content of this document, including but not limited to warranties of merchantability, fitness for a particular purpose, or non-infringement.

All statements, information, and suggestions in this document also do not constitute any form of guarantee or commitment

OLP EC-PV650_P500_E1205-AO01 户外集装箱储能系统用户手册	文件编号: OLPSID-MU-25061601 Document number: OLPSID-MU-25061601	版本:V1.1 Version:V1.1	Page 5 of 106
---	---	-------------------------	---------------

1. 缩略语 Abbreviations

缩略语 Abbreviation	中文 Description – CN	英文 Description – EN
OLP	欧力普能源与自动化技术有限公司	Olipower Technologies Co.,Ltd
BESS	电池储能系统	Battery Energy Storage System
BMS	电池管理系统	Battery Management System
BMU	电池管理单元	Battery Management Unit
BSU	电池采样单元	Battery Sampling Unit
BOL	生命周期起始	Beginning of Life
CAN	控制器局域网总线	Controller Area Network
DC	直流电	Direct Current
DOD	电池放电深度	Depth of Discharge
EOL	生命周期结束	End of Life
ESS	储能系统	Energy Storage System
FAT	工厂验收测试	Factory Acceptance Testing
HMI	人机界面	Human Machine Interface
IP	防护等级	Ingress Protection
kVA	千伏安	Kilo-Volt Ampere
kWh	千瓦时	Kilo-Watt Hour
MPPT	最大功率点跟踪器	Maximum Power Point Tracker
MCB	主断路器	Main Circuit Breaker
MCCB	塑壳断路器	Moulded Case Circuit Breaker
ms	毫秒	millisecond
MSD	手动维修开关	Manual Service Disconnect
PCS	储能变流器	Power Conversion System
PDU	配电单元	Power Distribution Unit
SAT	现场验收测试	Site Acceptance Testing
SCADA	监控与数据采集系统	Supervisory Control and Data Acquisition
SOC	电池荷电状态	State Of Charge
SOE	电池剩余能量状态	State Of Energy
SOH	电池健康状态	State Of Health
SOP	电池功率状态	State Of Power
UPS	不间断电源	Uninterruptible Power Supply

表 1-1 缩略语

Table 1-1 Abbreviations

OLP EC-PV650_P500_E1205-AO01 户外集装箱储能系统用户手册	文件编号: OLPSID-MU-25061601 Document number: OLPSID-MU-25061601	版本:V1.1 Version:V1.1	Page 6 of 106
---	---	-------------------------	---------------

2. 安全注意事项 Safety Precautions

本章介绍安全公告。在对设备进行任何操作之前，请仔细阅读用户手册，遵循操作和安装说明，并遵守所有危险、警告和安全信息，以避免不正常操作造成人身伤害和设备损坏。

This chapter introduces safety notices. Before performing any operation on the device, please carefully read the user manual, follow the operating and installation instructions, and comply with all danger, warning, and safety information to avoid personal injury and equipment damage caused by abnormal operation.

2.1. 安全公告 Safety Notice

本节主要介绍操作和维护时的安全注意事项。有关详细信息，请参阅相关章节中的安全说明。

This section mainly introduces safety precautions during operation and maintenance. For detailed information, please refer to the safety instructions in the relevant sections.



注意安全 Caution!

操作前，请仔细阅读本节的公告和操作说明，以免发生事故。

Before operation, please carefully read the announcement and operating instructions in this section to avoid accidents.

用户手册中的提示，如“危险”、“警告”、“小心”等，并不包括所有的安全公告。它们只是操作时安全公告的补充。

The prompts in the user manual, such as "Danger", "Warning", "Caution", etc., do not include all safety notices. They are just supplements to safety notices during operation.

任何因违反一般安全操作要求或设计、生产和使用的安全标准而造成的设备损坏将超出产品保修范围。

Any equipment damage caused by violation of general safety operation requirements or safety standards for design, production, and use will be beyond the scope of product warranty.

2.1.1. 使用公告 Usage Notice



危险 Danger

不要触摸与电网相连的端子或导体，以避免致命风险！

Do not touch terminals or conductors connected to the power grid to avoid fatal risks!



警告 Warning

设备内部没有操作部件。请不要自己打开系统外壳，否则可能会导致触电。非法操作造成的系统损坏超出了质保范围。

There are no operating components inside the device. Please do not open the system casing by yourself, otherwise it may cause electric shock. The system damage caused by illegal operations

OLP EC-PV650_P500_E1205-AO01 户外集装箱储能系统用户手册	文件编号: OLPSID-MU-25061601 Document number: OLPSID-MU-25061601	版本:V1.1 Version:V1.1	Page 7 of 106
---	---	-------------------------	---------------

exceeds the warranty scope.

危险 Danger

损坏的设备或设备故障可能导致触电或火灾！

Damaged equipment or equipment malfunctions may result in electric shock or fire!

- 在对设备进行任何操作之前，请目视检查设备是否没有损坏或危险。
Before performing any operation on the equipment, please visually inspect whether the equipment is damaged or dangerous.
- 检查其他外部设备或电路的连接是否安全。
Check if the connections of other external devices or circuits are secure.

危险 Danger

在检查或维护之前，如果直流侧和交流侧刚断电，则需要等待 20 分钟，以确保设备完全放电，然后才能进行操作。

Before inspection or maintenance, if the DC and AC sides have just been powered off, it is necessary to wait for 20 minutes to ensure that the equipment is completely discharged before proceeding with the operation.

警告 Warning

维修时，应确保所有开关已完全断开，并在断开位置设置警告标志，以避免意外重新连接。

When repairing, ensure that all switches are completely disconnected and set warning signs at the disconnected position to avoid accidental reconnection.

警告 Warning

请不要将手指或工具放入旋转的风扇中，以免造成人身伤害或设备损坏。

Please do not put your fingers or tools into the rotating fan to avoid personal injury or equipment damage.

注意安全 Caution!

不允许液体或其他物体进入设备。

Do not allow liquids or other objects to enter the container.

警告 Warning

如果发生火灾，请使用干粉灭火器。如果使用液体灭火器，可能会造成触电。

If a fire occurs, please use a dry powder fire extinguisher. If a liquid fire extinguisher is used, it may cause electric shock.

警告 Warning

设备上的标签包含有关安全操作的重要信息。不要撕毁或损坏它们！

The label on the device contains important information about safe operation. Do not tear or damage them!

OLP EC-PV650_P500_E1205-AO01 户外集装箱储能系统用户手册	文件编号: OLPSID-MU-25061601 Document number: OLPSID-MU-25061601	版本:V1.1 Version:V1.1	Page 8 of 106
---	---	-------------------------	---------------

2.1.2. 静电保护 Static Protection

注意安全 Caution!

为了防止人体静电对敏感元件（如电路板）造成损坏，在接触敏感元件之前，请确保佩戴防静电腕带，另一端接地良好。

To prevent damage to sensitive components (such as circuit boards) caused by human static electricity, please make sure to wear an anti-static wristband and with the other end well grounded before touching sensitive components.

2.1.3. 接地要求 Grounding Requirements

警告 Warning

泄漏风险高！进行电气连接之前，设备必须接地。接地端子必须接地。

High risk of leakage! Before making electrical connections, the equipment must be grounded. The grounding terminal must be grounded.

➤ 安装设备时，必须先将其接地。拆卸装置时，最后必须拆除接地线。

When installing equipment, it must be grounded first. When dismantling the device, the grounding wire must be removed at the end.

➤ 不要损坏接地导线。

Do not damage the grounding wire.

➤ 设备应永久连接到保护接地。操作前，应检查电气连接，确保设备可靠接地。

The equipment should be permanently connected to the protective grounding. Before operation, the electrical connections should be checked to ensure reliable grounding of the equipment.

2.1.4. 防潮保护 Moisture Protection

注意安全 Caution!

湿气侵入可能会导致系统损坏！

Moisture intrusion may cause system damage!

观察以下项目以确保设备正常工作。

Observe the following items to ensure that the equipment is functioning properly.

➤ 当环境湿度超过 95% 时，不要打开设备的门。

Do not open the door of the equipment when the environmental humidity exceeds 95%.

➤ 在潮湿或潮湿的天气下，不要打开设备的门进行维护或修理。

Do not open the door of the equipment for maintenance or repair in damp or humid weather.

OLP EC-PV650_P500_E1205-AO01 户外集装箱储能系统用户手册	文件编号: OLPSID-MU-25061601 Document number: OLPSID-MU-25061601	版本: V1.1 Version: V1.1	Page 9 of 106
---	---	---------------------------	---------------

2.1.5.安全警告标签设置 Security Warning Label Setting

为了避免意外人员靠近设备或操作不当，在进行安装、日常维护或维修时应遵守以下要求。

To avoid accidental personnel approaching the equipment or improper operation, the following requirements should be followed during installation, daily maintenance, or repair.

- 在电池输入端和交流输入端的开关处设置警告标签，以避免开关不当。
Set warning labels at the switches of the battery input and AC input to avoid improper switching.
- 在操作区域设置警告标志或安全警示带，以避免人身伤害或设备损坏。
Set up warning signs or safety warning tapes in the operating area to avoid personal injury or equipment damage.
- 维修后，确保拔出设备门的钥匙并妥善保存。
After maintenance, make sure to remove the key to the equipment door and store it properly.

2.1.6.设备运行中的测量 Measurement During Operation

设备中存在高电压。若不慎触碰设备，可能会导致触电。因此，在设备运行中进行测量操作时，操作人员必须有人陪同，并采取保护措施（如戴绝缘手套等）。

There is high voltage in the device. If accidentally touched, it may cause electric shock. Therefore, when conducting measurement operations during equipment operation, the operator must be accompanied by someone and take protective measures (such as wearing insulated gloves).

测量装置必须满足以下要求：

The measuring device must meet the following requirements:

- 测量装置的量程和操作要求满足现场要求。
The measuring range and operational requirements of the measuring device meet the on-site requirements.
- 测量装置的连接应正确且标准，以避免电弧。
The connection of the measuring device should be correct and standardized to avoid arcing.

2.2.操作员要求 Operator Requirements

设备的操作和接线应由合格人员进行，以确保电气连接符合相关标准。

The operation and wiring of the equipment should be carried out by qualified personnel to ensure that the electrical connections comply with relevant standards.

在安装、操作和维护设备之前，操作员必须了解安全公告，知道正确的操作，并接受严格的培训。

Before installing, operating, and maintaining the equipment, the operator must understand the safety notice, know the correct operation, and receive strict training.

- 操作员应熟悉本产品的结构和工作原理。
The operator should be familiar with the structure and working principle of this product.
- 操作员必须熟悉相关的国家和地区标准。
Operators must be familiar with relevant national and regional standards.

Olp EC-PV650_P500_E1205-AO01 户外集装箱储能系统用户手册	文件编号：OLPSID-MU-25061601 Document number: OLPSID-MU-25061601	版本:V1.1 Version:V1.1	Page 10 of 106
©欧力普能源与自动化技术有限公司 2025 保留所有权利 © Olipower Energy & Automation Technologies 2025 All rights reserved.	地址：深圳市光明区凤凰街道塘尾社区光明大道 380 号尚智科技园 2 栋 A 座 10 楼 Address: 10th Floor, Block A, Building 2, Shangzhi Science and Technology Park, No. 380 Guangming Avenue, Tangwei Community, Fenghuang Street, Guangming District, Shenzhen, China.		Tel: +86 (755) 2650 8686 Website: www.olipower.cn

2.3. 运行环境要求 Operating Environment Requirements

操作环境可能会影响设备的使用寿命和可靠性。因此，请避免在以下环境中使用设备：

The operating environment may affect the service life and reliability of the equipment. Therefore, please avoid using the device in the following environments:

- 温度和湿度超过技术规范的地方（温度：-20°C~+55°C；相对湿度：0%~95%）。
Places where the temperature and humidity exceed the technical specifications (temperature: -20 °C~+55 °C; relative humidity: 0%~95%).
- 有振动或冲击的地方。
Places with vibration or impact.
- 有灰尘、腐蚀性物质、盐或可燃气体的地方。
Places with dust, corrosive substances, salt, or flammable gases.
- 通风不良或封闭的地方。
Poor ventilation or enclosed areas.

OLP EC-PV650_P500_E1205-AO01 户外集装箱储能系统用户手册	文件编号：OLPSID-MU-25061601 Document number: OLPSID-MU-25061601	版本:V1.1 Version:V1.1	Page 11 of 106
©欧力普能源与自动化技术有限公司 2025 保留所有权利 © Olipower Energy & Automation Technologies 2025 All rights reserved.	地址：深圳市光明区凤凰街道塘尾社区光明大道 380 号尚智科技园 2 栋 A 座 10 楼 Address: 10th Floor, Block A, Building 2, Shangzhi Science and Technology Park, No. 380 Guangming Avenue, Tangwei Community, Fenghuang Street, Guangming District, Shenzhen, China.	Tel: +86 (755) 2650 8686 Website: www.olipower.cn	

3. 产品技术规格 Product Technical Specification

3.1. 产品型号 Product Model

产品型号为：OLP EC-PV650_P500_E1205-AO01

3.2. 产品铭牌 Product Nameplate

 Battery Energy Storage System	
System Parameters	Product Model: OLP-EC-PV650_P500_E1205-AO01
Rated Cell Capacity: 314Ah	Manufacturing Date: May.2025
Rated Current: 722A	Altitude: < 3000m
Maximum PV: 720kW	IP Class: IP54
Rated AC Power: 500kW	Weight: approx. 20.0 tons
Maximum Energy: 1.2MWh	External Dimensions:
Voltage Ranges: DC 672V~876V	6058mmx2438mmx2896mm
Rated Voltage: DC 768V	
<p>Warning: High voltage is dangerous, do not approach! Non-professionals, please do not operate without permission! Please read the user manual carefully before use!</p>	

图 3.2-1 铭牌说明

Figure 3.2-1 Nameplate Description

OLP EC-PV650_P500_E1205-AO01 户外集装箱储能系统用户手册	文件编号: OLPSID-MU-25061601 Document number: OLPSID-MU-25061601	版本:V1.1 Version:V1.1	Page 12 of 106
---	---	-------------------------	----------------

3.3. 产品规格 Product Specifications

	项目 Item	规格 Specification
电芯参数 Cell Parameters	额定电压(V) Rated Voltage(V)	3.2
	额定电量(Ah) Rated Energy(Ah)	314
	电芯类型 Cell Type	磷酸铁锂 LFP
	循环次数 Cycle	>6000 (25°C,0.5C/0.5C,90%DOD,80%SOH)
电池包参数 Battery Pack Parameters	额定电压(V) Rated Voltage(V)	51.2
	额定电量(kWh) Rated Energy(kWh)	16.1
	电芯成组方式 Cell Configuration	1P16S
	尺寸(宽*高*深)mm Dimension(W*H*D)mm	464*230*803
	冷却方式 Cooling Method	强制风冷 Forced air cooling
	重量(kg) Weight(kg)	128
	防护等级 IP Grade	IP20
电池簇参数 Battery Cluster Parameters	电池簇额定电压(V) Cluster Rated Voltage(V)	768
	电池簇电压范围(V) Cluster Voltage Range(V)	672~864
	簇成组方式 Configuration	15S
	额定充/放电电流(A) Rated Charge/Discharge Current(A)	157
	最大充/放电电流(A) Max. Charge/Discharge Current(A)	157
	电池簇额定电量(kWh) Cluster Rated Energy(kWh)	241

	高压箱电压(Vdc) HVBOX Voltage(Vdc)	1000
	高压箱电流(A) HVBOX Current(A)	200
	热管理 Thermal Management	空调 Air conditioner
	消防系统 Fire Protection System	温度传感器/烟雾传感器/全氟己酮 Heat Detector/Smoke Detector/Perfluorohexanone
	防护等级 IP Grade	IP54
	防腐等级 Anti-Corrosion Grade	C3
	工作温度 Working Temperature (°C)	-20~+55
	存储温度 Storage Temperature (°C)	-20~+45
	湿度 Humidity	0~95%(No condensation)
	海拔高度 Latitude(m)	≤3000
光伏输入参数 PV input Parameters	最大光伏输入电压 Max. PV in Put Voltage	1000V
	光伏功率 PV Power	650kW
	MPPT 模块数量 No. of MPPT	6
	MPPT 电压范围 MPPT Voltage Range	250 ~ 850V
并网输出参数 On-Grid output Parameters	额定输出功率 Rated output Power	500kW
	最大输出功率 Max. output Power	550KW
	电网类型 Type of Power Grid	3W+N+PE
	电网电压 Grid Volatge	400(320~460)V
	额定输出电流 Rated output Current	722A
	额定电网频率 Rated Grid Frequency	50(45~55)/60(55~65)Hz

OLP EC-PV650_P500_E1205-AO01 户外集装箱储能系统用户手册	文件编号: OLPSID-MU-25061601 Document number: OLPSID-MU-25061601	版本:V1.1 Version:V1.1	Page 14 of 106
---	---	-------------------------	----------------

	功率因数 Power Factor	1 超前~1 滞后 (可设置) 1leading~1lagging (Configurable)
	THDi	<3%
离网输出参数 Off-Grid output Parameters	额定输出功率 Rated output Power	500kW
	最大输出功率 Max. output Power	550KW
	额定输出电压 Rated output Voltage	400V
	额定输出电流 Rated output Current	722A
	THDU	≤1%线性; 或≤5%非线性 ≤1% linear; Or ≤5% nonlinear
	额定输出频率 Rated output Frequency	50/60Hz
	过载能力 Overload capacity	110%长期, 120%1 分钟 110% for a long time, 120% for 1 minute

表 3.3-1 产品规格参数

Table 3.3-1 Product Specification

3.4. 应用场景 Application scenarios

微网集装箱是一种集成化的能源解决方案，通过将储能系统、分布式电源、智能控制系统等核心组件整合在标准集装箱内，实现灵活、高效的电力供应。其特点及应用场景如下：

Microgrid containers are an integrated energy solution. By integrating core components such as energy storage systems, distributed power sources, and intelligent control systems within standard containers, they achieve flexible and efficient power supply. Its features and application scenarios are as follows:

场景 1：偏远地区电力保障与农村电气化

Scene 1: Power Supply Guarantee in Remote Areas and rural electrification

针对非洲、东南亚等电网覆盖不足地区，微网集装箱通过“光伏 + 储能 + 柴发”模式提供稳定电力。For regions such as Africa and Southeast Asia where power grid coverage is insufficient, microgrid containers provide stable electricity through the "photovoltaic + energy storage + diesel power generation" model.

场景 2：海岛与离网型社区能源自给

Scene 2: Energy self-sufficiency in islands and off-grid communities

海岛因运输成本高、传统电网难以接入，微网集装箱成为理想选择。

Due to the high transportation costs and the difficulty in accessing traditional power grids, microgrid

OLP EC-PV650_P500_E1205-AO01 户外集装箱储能系统用户手册	文件编号: OLPSID-MU-25061601 Document number: OLPSID-MU-25061601	版本:V1.1 Version:V1.1	Page 15 of 106
---	---	-------------------------	----------------

containers have become an ideal choice for islands.

场景 3：工业高能耗场景与绿色转型

Scene 3: High Energy Consumption Scenarios in Industry and Green Transformation

矿区、工业园区等场景面临用电波动大、峰谷电价差显著的问题。

Mining areas, industrial parks and other scenarios are confronted with problems such as large fluctuations in electricity consumption and significant differences between peak and off-peak electricity prices.

场景 4：应急救援与临时供电

Scene 4: Emergency disaster relief and temporary power supply

微网集装箱的便携性使其成为应急电力的核心装备。

The portability of microgrid containers makes them the core equipment for emergency power supply.



图 3.4-1 系统拓扑图

Figure 3.4-1 System Topology Diagram

3.5. 系统运行模式 System operation mode

工作模式介绍 Introduction of work mode.

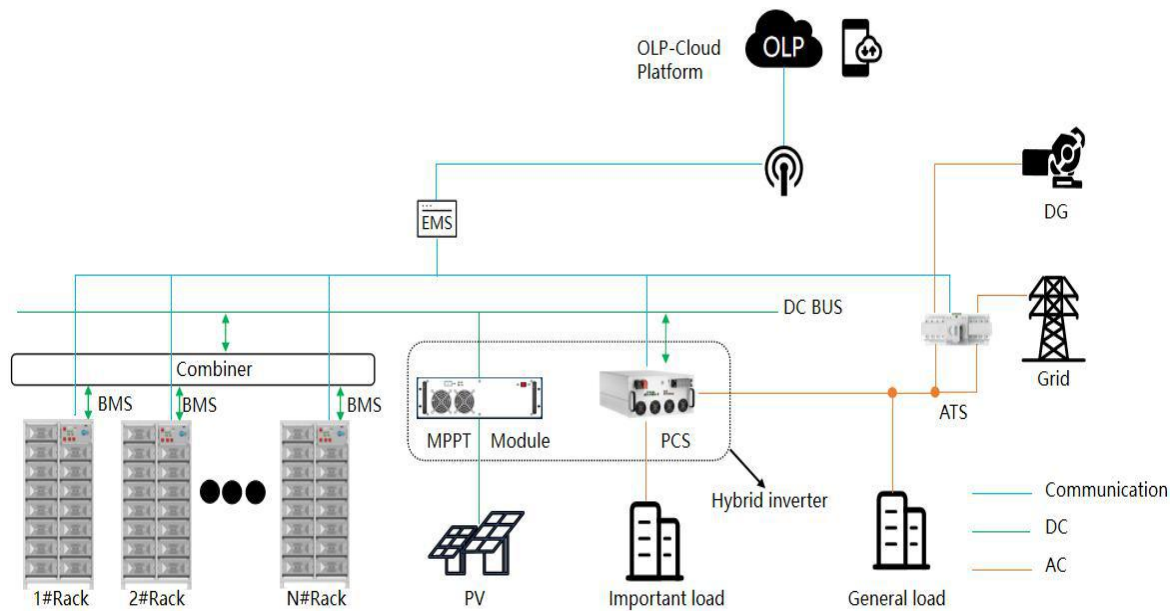
混合逆变器的工作模式可通过触摸屏进行设置。该系统的工作模式是“自发自用”，如果您需要切换成其他工作模式，请与制造商联系。

The working mode of the hybrid inverter can be set through the touch screen. The working mode of this system is "self-generated and self-used". If you need to switch to another working mode, please contact the manufacturer.

OLP EC-PV650_P500_E1205-AO01 户外集装箱储能系统用户手册	文件编号: OLPSID-MU-25061601 Document number: OLPSID-MU-25061601	版本:V1.1 Version:V1.1	Page 16 of 106
---	---	-------------------------	----------------

用户点击“菜单”→“系统”可根据不同要求选择工作模式（供参考）：

User select work pattern according to different demands (for reference) by clicking the “Menu”-“System”.

工作模式: 自发自用 Work pattern: self-use

- 光伏优先为负载供电，当光伏功率 > 负载功率时，余电给电池充电。若电池充满，余电上网或光伏控制器限功率。
- 光伏优先为负载供电，当光伏功率 < 负载功率时，光伏和电池联合给负载供电。
- 光伏优先为负载供电，当（光伏 + 电池）功率 < 负载功率时，电网、光伏和电池将同时为负载供电。

Work pattern: self-use

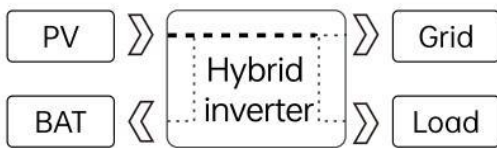

1. PV power > the load power, the residual power charge the battery. If the battery is fully charged, the residual power will connect to the power grid or the PV controller will limit the power.

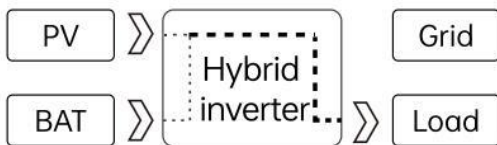

2. Photovoltaics prioritize power to loads. When the PV power < the load power, the photovoltaic and the battery jointly supply power to the load.

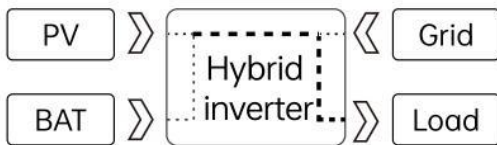

3. Photovoltaics prioritize power to loads. When (PV + battery) power < the load power, the grid, photovoltaic and battery will simultaneously supply power to the load.

工作模式: 电池优先 Work pattern: battery priority

- 光伏优先为电池充电，多余的能量则提供给负载，如果还有多余的能量，则输送给电网。
- 当光伏的能量不足以为电池和负载供电时，电网给负载提供剩余的能量。
- 当光伏没有能量时，电网就会向负载提供能量。

OLP EC-PV650_P500_E1205-AO01 户外集装箱储能系统用户手册	文件编号: OLPSID-MU-25061601 Document number: OLPSID-MU-25061601	版本: V1.1 Version: V1.1	Page 17 of 106
---	---	---------------------------	----------------

Work pattern: battery priority

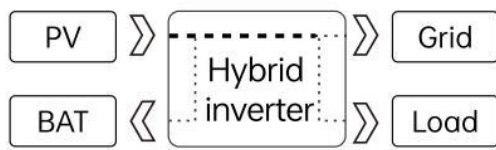

1. Photovoltaics prioritize charge the battery, the residual energy supplies power to the load. When there is still energy left, it will be fed to the power grid.

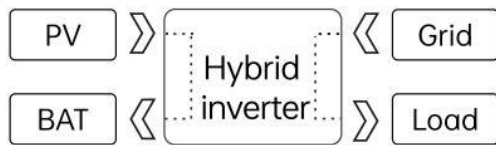

2. In the case of insufficient photovoltaic energy to power the battery and load, the grid provides the rest of the energy required for the load.

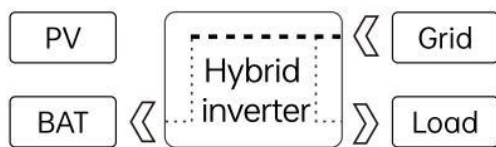

3. In the absence of photovoltaic energy, the grid will supply energy to the load.

工作模式: 最优模式 Work pattern: optimal mode

- 当有足够的光伏能量时，光伏会在为电池充电的同时为负载供电，如果还有剩余，就会输送到电网。
- 当光伏能量不足时，光伏会给电池充电，同时为负载供电，此时电网会给负载补足剩余的能量。
- 当光伏能量不足时，光伏将为电池充电：如果负载的功率小于交流侧设定的功率值，交流侧将为负载提供能量，剩余能量将为电池充电。
- 当光伏的能量不足，而负载的功率大于设定的交流侧功率时，交流侧的可用功率将全部供给负载，光伏将补充剩余的不足能量；如果光伏补充的能量不足，电池将补充剩余能量。
- 当光伏不可用且负载功率小于交流电设置的功率值时，交流侧会给负载提供能量，同时剩余的能量将为电池充电。
- 当光伏不可用且负载功率大于交流侧设定的功率值时，交流侧和电池一起为负载供电。

Work pattern: optimal mode

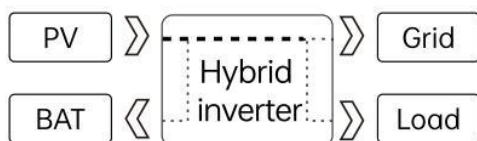

1. If there is enough photovoltaic energy, the photovoltaic will charge the battery and power the load at the same time, and if there is any surplus, it will be sent to the grid.

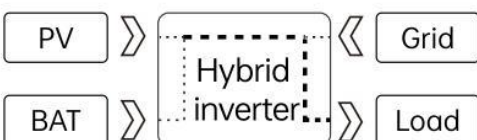

2. When the photovoltaic energy is insufficient, the photovoltaic will charge the battery and power the load at the same time, and the grid will make up the remaining energy required for the load.

OLP EC-PV650_P500_E1205-AO01 户外集装箱储能系统用户手册	文件编号: OLPSID-MU-25061601 Document number: OLPSID-MU-25061601	版本: V1.1 Version: V1.1	Page 18 of 106
---	---	---------------------------	----------------

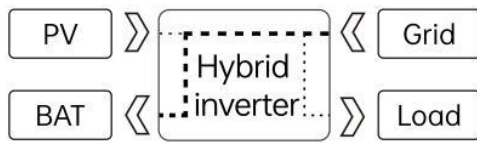

3. When the photovoltaic energy is insufficient, the photovoltaic will charge the battery: if the power of the load is less than the power value set by the AC power, the AC side will provide energy for the load, and the remaining energy will charge the battery.



4. When the energy of photovoltaic is insufficient, and the power of the load is greater than the value set by the AC power, the available power of the AC side will all supply the load, and the photovoltaic will supplement the remaining insufficient energy, If the photovoltaic energy supply is insufficient, the battery will supplement the remaining energy.

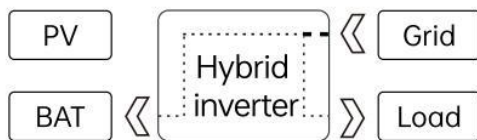

5. When the photovoltaic is not available and the load power is less than the power value set by the AC power, the AC side will supply power to the load, and the remaining power will charge the battery.

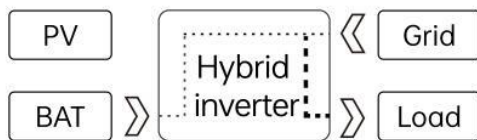

6. When the photovoltaic is not available and the load power is greater than the power value set by the AC power, the AC side and the battery supply power to the load.

工作模式：混合模式 Work pattern: mixed mode

注：“混合模式”主要有以下这些功能：

- 1) 经济模式。
 - a、峰段：执行“自发自用”模式，由电池提供负载所需的能量。
 - b、平段：执行“自发自用”模式，由电网提供负载所需的能量。
 - c、谷段：执行“电池优先”模式，电网给电池充电，同时提供负载所需的能量。
- 2) 削峰填谷：根据设定的功率值的正负（正放负充）来控制对电池的充放。其次，可以通过选择“发电机动作”来控制发电机的开启 / 关闭。

注意！如果设置防逆流功能使能，在所有工作模式下，系统都将不向电网供电。混合模式以实际应用为准。

OLP EC-PV650_P500_E1205-AO01 户外集装箱储能系统用户手册	文件编号：OLPSID-MU-25061601 Document number: OLPSID-MU-25061601	版本:V1.1 Version:V1.1	Page 19 of 106
---	--	-------------------------	----------------

Check	Peak-Flat-Valley	Start Time	End Time	Features	Power (kW)
√	Peak price	9:00	10:00	System for self-use	10
√	Peak price	9:00	10:00	System for self-use	10

↓	↓	↓	↓	↓	↓
Enable	Select the peak segment, flat segment and valley segment when peak-load shifting.	Arrive at this time, the system starts to run automatical.	Arrive at this time, the system stops running automatical.	Functions performed in the current time range.	Operating power of peak-load shifting.

Note: "Mixed mode" has the following functions:

1. Economic mode

- a. Peak segment: execute the "self-use" mode, and the battery provides the energy required for the load.
- b. Flat segment: the implementation of "self-use" mode, the power grid provides the energy required for the load.
- c. Valley segment: the implementation of the "battery priority" mode, the grid charge the battery, while providing the load required energy.

2. Peak-load shifting: according to the set power value of positive and negative (positive discharge negative charge) to control the battery charge. Secondly, the generator can be turned on/off by selecting "generator action".

Note: If the anti-reverse function is set to enable, the system will not supply power to the grid in all working modes.

3.6. 系统原理图 System Schematic Diagram

20 尺微网集装箱系统采用 All in one 设计，集成电池系统、储能 PCS、光伏逆变器、柴发接口、EMS、温控系统、消防系统、配电箱等器件，构建完整微网系统，接入光伏、负载后即可快速投入使用。其系统原理图如下：

The 20-foot microgrid container system adopts an all-in one design, integrating components such as battery systems, energy storage PCS, photovoltaic inverters, diesel engine interfaces, EMS, temperature control systems, fire protection systems, and distribution boxes to build a complete microgrid system. It can be put into use quickly after being connected to photovoltaic and loads. The system schematic diagram is as follows:



图 3.6-1 系统原理图

Figure 3.6-1 System schematic diagram

3.7. 产品外观 Product Appearance

3.7.1. 外观和尺寸 Appearance and Dimensions

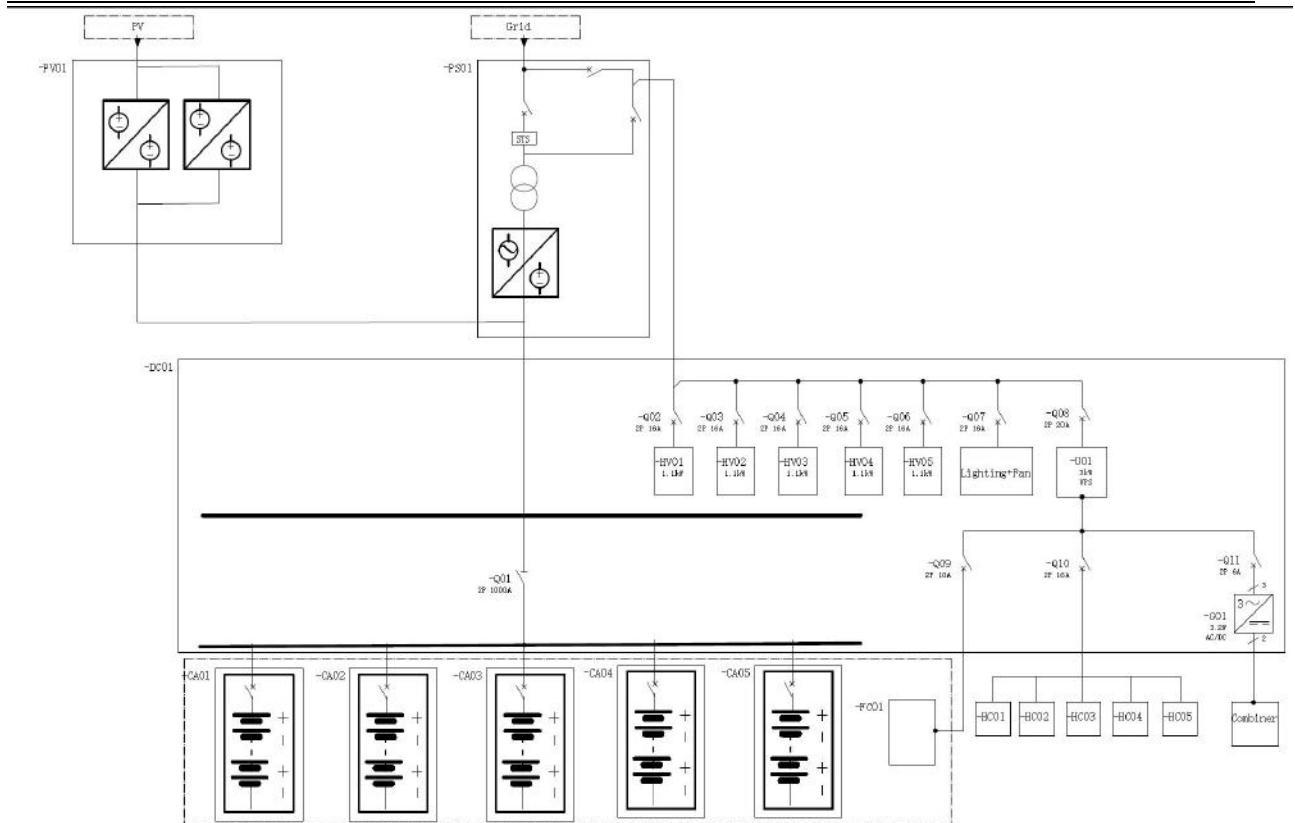

图 3.7.1-1 外观

Figure 3.7.1-1 Appearance



图 3.7.1-2 尺寸 (单位: mm)
Figure 3.7.1-2 Dimension (unit: mm)

3.7.2.显示面板 Display Panel

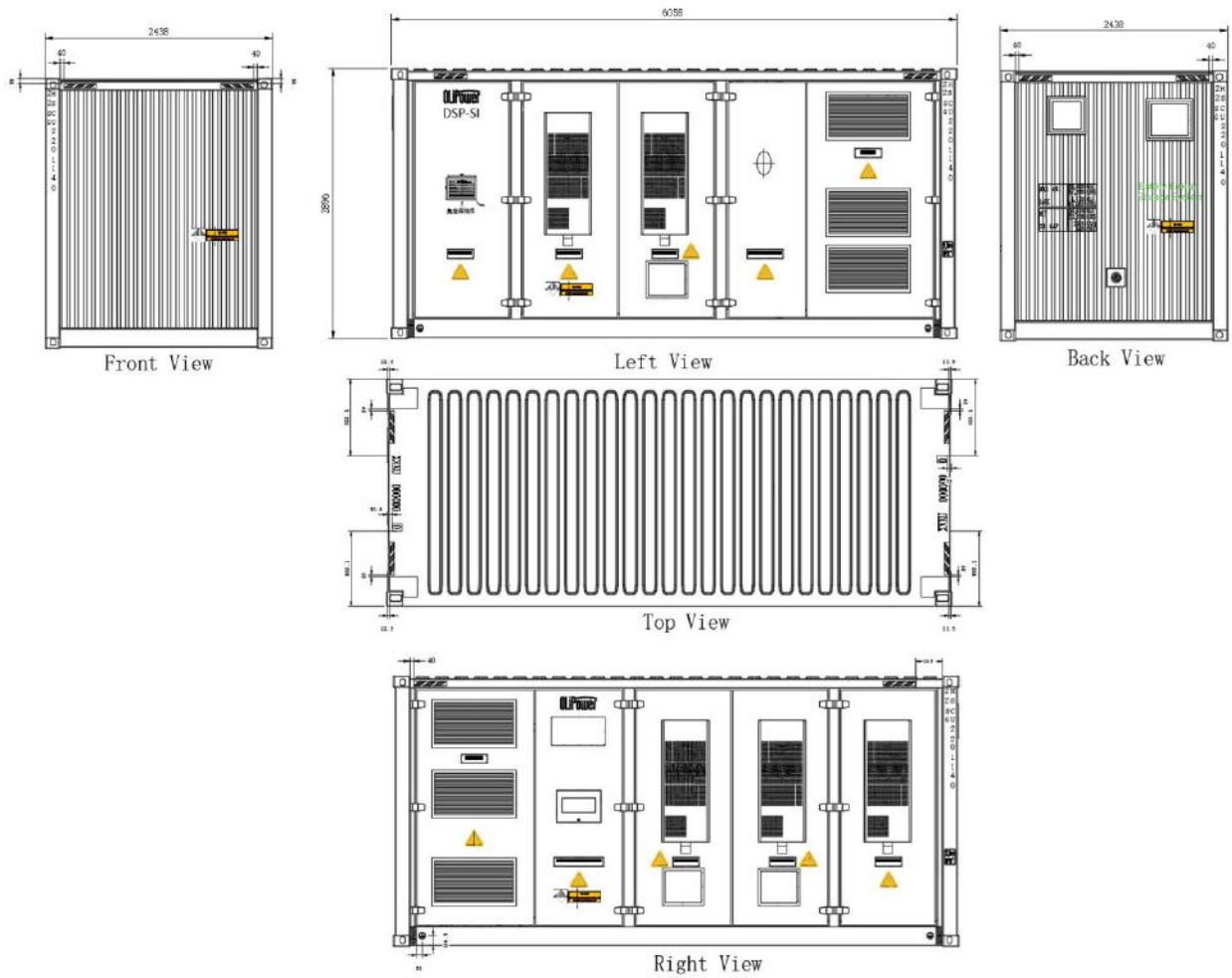

图 3.7.2-1 显示面板
Figure 3.7.2-1 Display panel

<p>OLP EC-PV650_P500_E1205-AO01 户外集装箱储能系统用户手册</p>	<p>文件编号: OLPSID-MU-25061601 Document number: OLPSID-MU-25061601</p>	<p>版本:V1.1 Version:V1.1</p>	<p>Page 23 of 106</p>
---	---	---------------------------------	-----------------------

序号 NO.	条目 Item	说明 Specification
1	HMI	人机交互界面，根据触摸屏的内容进行对应的操作 Human interaction interface, perform corresponding operations based on the content of the touch screen
2	E-STOP	按下急停按钮，系统停止输出 Press the emergency stop button, and the system will stop outputting

表 3.7.2-2 显示面板说明

Table 3.7.2-2 Display Panel Description

3.8. 部件说明 Component Description



图 3.8-1 部件说明图示 A 面

Figure 3.8-1 Component Description Diagram (Side A)

序号 No.	名称 Name	说明 Description
1	变流器 PCS	变流器将进行直流与交流变换 The inverter will perform DC and AC conversion
2	门禁系统 Access control	系统配备门禁开关 The system is equipped with door switches that are responsible for light on and off.

3	热管理系统 Thermal management system	系统配备空调，空调负责储能系统的温度调节 The system is equipped with an air conditioner which is responsible for the temperature regulation of battery.
4	电池箱 Battery packs	系统配备 15 个风冷电池箱 The system is equipped with 15 air-cooled battery packs with BSU to monitor battery data.
5	高压控制箱 HVbox	系统配备 1 个高压控制箱，含 BMU，负责电池簇的监控和保护 System is equipped with HVbox with BMU for monitoring and protection of the battery cluster.
6	消防系统 Fire protection system	配置温感、烟感和全氟己酮，实现消防保护 Configure heat detector, smoke detector, and Perfluorohexane to achieve fire protection
7	触摸屏 HMI	操作与系统状态界面 System operation and system status display.

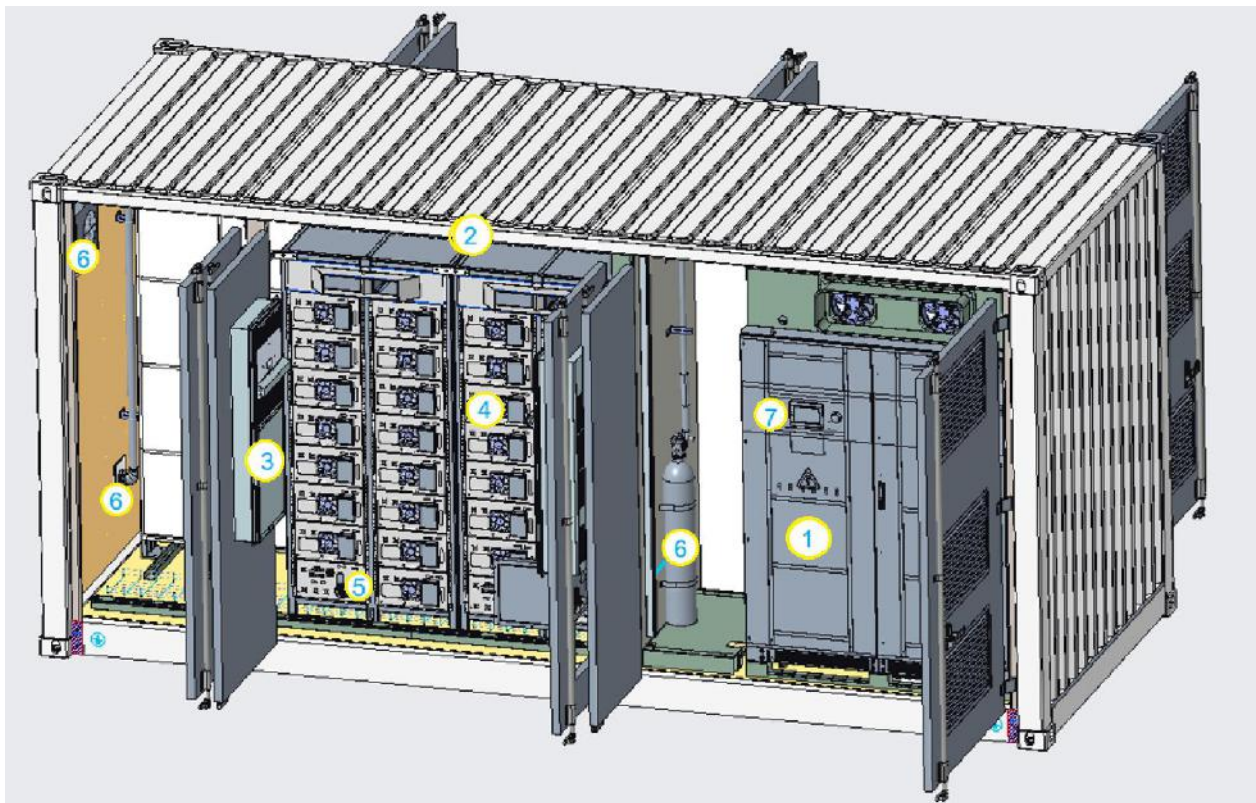
表 3.8-2 部件说明表 A 面
Table 3.8-2 Component Description Table (Side A)



图 3.8-3 部件说明图示 B 面
Figure 3.8-3 Component Description Diagram (Side B)

序号	名称	说明
OLP EC-PV650_P500_E1205-AO01 户外集装箱储能系统用户手册	文件编号: OLPSID-MU-25061601 Document number: OLPSID-MU-25061601	版本:V1.1 Version:V1.1
©欧力普能源与自动化技术有限公司 2025 保留所有权利 © Olipower Energy & Automation Technologies 2025 All rights reserved.		地址: 深圳市光明区凤凰街道塘尾社区光明大道 380 号尚智科技园 2 栋 A 座 10 楼 Address: 10th Floor, Block A, Building 2, Shangzhi Science and Technology Park, No. 380 Guangming Avenue, Tangwei Community, Fenghuang Street, Guangming District, Shenzhen, China.
		Page 25 of 106 Tel: +86 (755) 2650 8686 Website: www.olipower.cn

No.	Name	Description
1	光伏逆变器 MPPT	追踪光伏电力最大功率点 Track the maximum power point of photovoltaic power
2	配电柜 Power Distribution Cabinet	空调、消防、高压箱和其他的交流、直流供电，电池的直流侧并联 Air conditioning, fire protection, high-voltage box, and other AC and DC power supplies, with parallel connection of the DC side of the battery
3	热管理系统 Thermal management system	系统配备空调，空调负责储能系统的温度调节 The system is equipped with an air conditioner which is responsible for the temperature regulation of battery.
4	电池箱 Battery packs	系统配备 15 个风冷电池箱 The system is equipped with 15 air-cooled battery packs with BSU to monitor battery data.
5	高压控制箱 HVbox	系统配配备 1 个高压控制箱，含 BMU，负责电池簇的监控和保护 System is equipped with HVbox with BMU for monitoring and protection of the battery cluster.
6	消防系统 Fire protection system	消防系统：排风风机、泄压阀、消防水栓 Fire protection system: exhaust fan, pressure relief valve, fire hydrant

表 3.8-4 部件说明表 B 面
Table 3.8-4 Component Description Table (Side B)

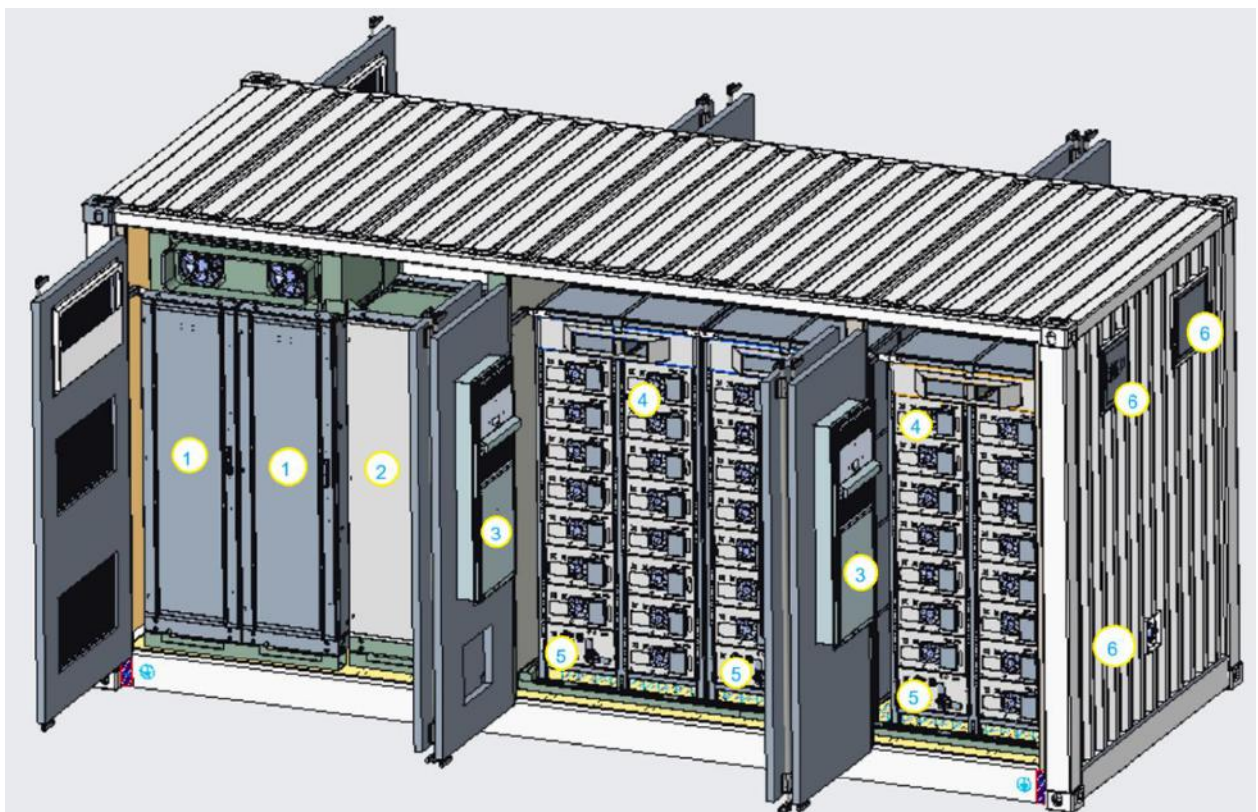
3.8.1. 储能系统 Energy Storage System

1) 电池包规格参数 Battery pack specification

序号 No.	项目 Item	规格参数 Specifications
1	标称电压(V) Rate Voltage(V)	51.2
2	工作电压范围(V) Operating voltage range (V)	44.8~57.6
3	额定容量(Ah) Rated capacity (Ah)	≥314 (25°C,0.5C, 2.5-3.65V)
4	额定电量(kWh) Rated power (kWh)	≥16.07 (25°C,0.5C, 2.5-3.65V)
5	成组方式 Grouping method	1P16S
6	重量(Kg) Weight (Kg)	128
7	尺寸(W*H*D) (mm) Dimension (W*H*D) (mm)	460*230*803

OLP EC-PV650_P500_E1205-AO01 户外集装箱储能系统用户手册	文件编号: OLPSID-MU-25061601 Document number: OLPSID-MU-25061601	版本:V1.1 Version:V1.1	Page 26 of 106
---	---	-------------------------	----------------

8	标准充放电电流(A) Standard charge/discharge Current(A)	157
9	最大充放电电流(A) Max charge/discharge Current(A)	157
10	循环次数 Cycle Time	>6000 (25°C,0.5C/0.5C,90%DOD,80%SOH)
11	充电温度范围(°C) Charging temperature range	0~+55
12	放电温度范围(°C) Discharging temperature range	-20~+55
13	储存温度范围(°C) Storage temperature range (°C)	-20~+50
14	湿度(%) Humidity (%)	0~95 (No condensation)
15	海拔高度(m) Altitude(m)	≤3000
16	模组冷却方式 Module Cooling Method	强制风冷 Forced air cooling
17	模组自放电率 Module self-discharge Rate	≤3% /月 ≤3% / month
18	防护等级 IP Grade	IP20
19	防腐蚀等级 Anti-corrosion Grade	C3
21	外观 Appearance	

表 3.8.1-1 电池箱参数表

Table 3.8.1-1 Battery Pack specification

2) 电池包面板定义 Battery pack front panel defination

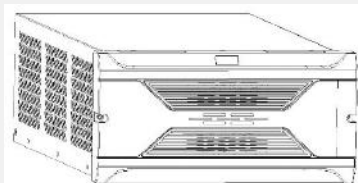

图 3.8.1-2 电池包前面板定义
Figure 3.8.1-2 Battery pack front panel

序号 No.	定义 Defination
A	电池正极 Battery positive
B	电池负极 Battery negative
C/D	通讯端口 Communication port
E	散热风扇 Cooling fan
F	接地螺丝 Grounding screw
G	BSU

表 3.8.1-3 电池包面板接口说明
Table 3.8.1-3 Description of battery pack front panel

管脚 PIN	COM IN 管脚定义 COM IN PIN definition	COM OUT 管脚定义 COM OUT PIN definition
1	24V+	24V+

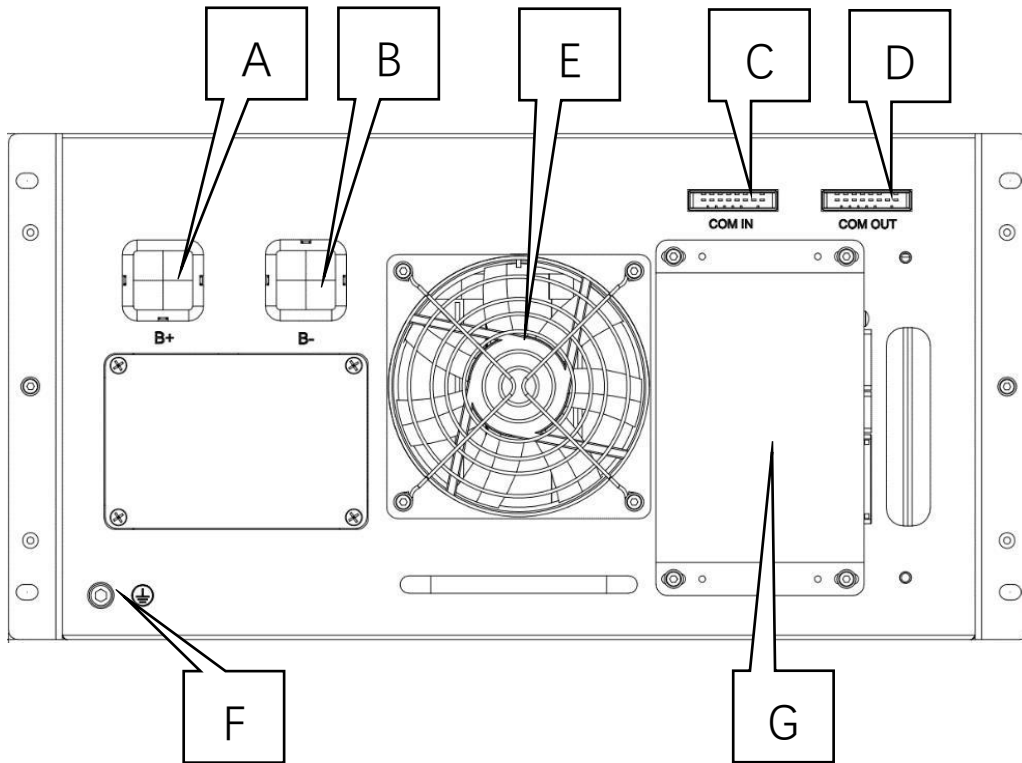
2	24V-	24V-
3	N/C	N/C
4	N/C	N/C
5	WDI+	WDO+
6	WDI-	WDO-
7	CANH	CANH
8	CANL	CANL

表 3.8.1-4 通讯端口定义

Table 3.8.1-4 Communication port definition

3) 高压控制箱 HVbox

高压控制箱内部包 BMU(电池管理单元), 高压接触器, 高压熔断器, 电流互感器等, 用于控制直流回路的闭合和切断, 实现直流侧电压, 温度, 电流的各级保护。

The HVbox contains BMU (Battery Management Unit) high-voltage contactors, high-voltage fuses, current transformers, etc. Used to control the closure and disconnection of DC circuits. Realize various levels of protection for DC side voltage, temperature, and current.

序号 No.	项目 Item	规格/参数 Specifications
1	工作电压 Working voltage	DC1000V
2	辅助电源 Auxiliary power supply	230V/50Hz/10A
4	额定充/放电电流 Rated charge/discharge current	200A/200A
5	主动保护 Active protection	250A 接触器 250A contactor
6	被动保护 Passive protection	250A/1000Vdc 熔断器 250A/1000Vdc Fuse
7	手动断路器 Manual circuit breaker	200A/1500Vdc 隔离开关 200A/1500Vdc Isolator
8	工作温度 operating temperature	-20~+55°C
9	存储温度范围 Storage temperature range	-20~+50°C
10	串联单元	最大 16 个电池模组串联 Max 16 Battery packs in series
11	对外通讯接口 External communications interface	CAN
12	并联通讯接口 Parallel communication interface	CAN
13	内部通讯接口 Internal communication interface	CAN

14	维护监控接口 Maintenance monitoring interface	RS232
15	空调通讯接口 Air Conditioner communication interface	RS485
16	尺寸(宽*高*厚) Dimensions (W*H*T)	464*230*720mm
17	重量 Weight	31kg
18	防护等级 IP grade	IP20
19	外观 Appearance	

表 3.8.1-5 电池箱参数表
Table 3.8.1-5 HVbox Parameters

4) 高压箱前面板定义 HVbox front panel defination

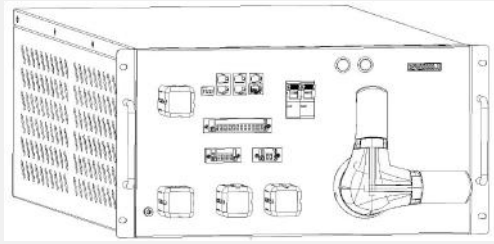

图 3.8.1-6 高压箱前面板定义
Figure 3.8.1-6 HVbox front panel defination

序号 No.	定义 Defination
A	电池正极 Battery positive
B	通讯接口板 Communication interface board
C	DI/DO
D	辅助电源交流断路器 Auxiliary power supply MCB
E	故障灯 Alarm indicator
F	运行灯 Run indicator
G	电池包通讯接口 Communication port to Battery Pack
H	电池负极 Battery negative
I	风扇输出控制 Fan output control
J	负载正极 Load positive
K	负载负极 Load negative
L	辅助电源交流输入(AC230V/10A) Auxiliary power supply input(AC230V/10A)
M	隔离开关 Isolator

表 3.8.1-7 高压箱前面板定义
Table 3.8.1-7 HVbox front panel defination

RJ45 PIN	PARA-A PARA-B	COMMISSIONING	PCS	MONITOR	COMM
	多簇并联通讯口 Multi clusters Parallel CAN port	BMS 内部调试口 BMS internal debug port	对外 CAN 接口 External CAN Port	上位机监控接口 Monitor port	RS232/RS485 接口 RS232/RS485 port
1	CAN2H	CAN1H	CAN3H	TXD2	TXD1
2	CAN2L	CAN1L	CAN3L	RXD2	RXD1
3				GND2	GND1
4				VCC2	VCC1
5					

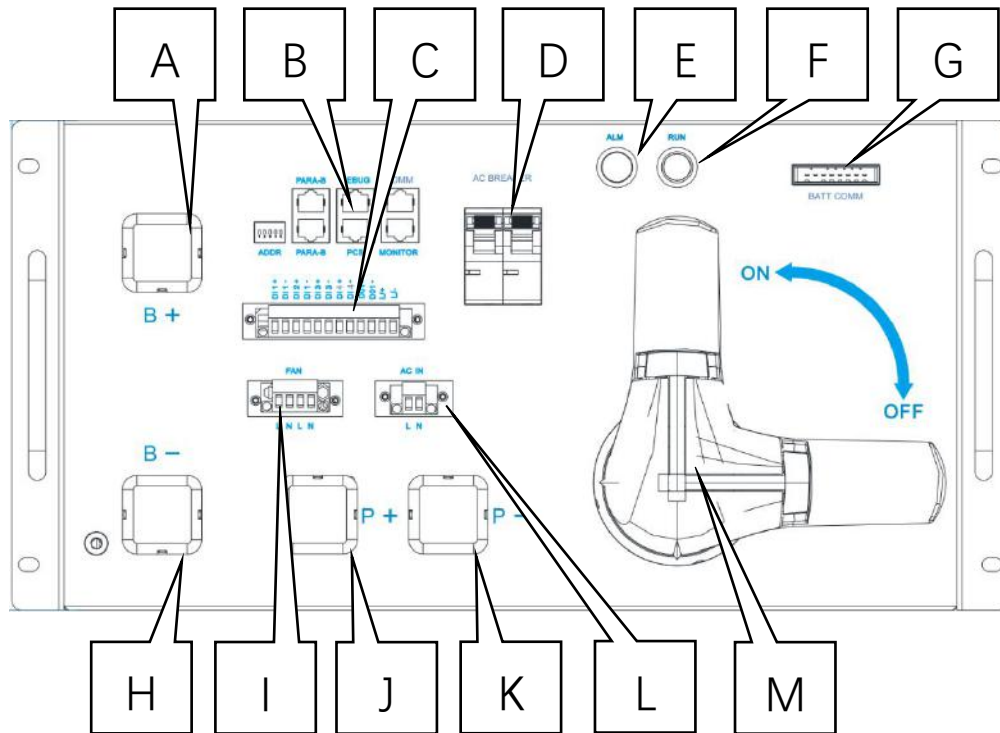
OLP EC-PV650_P500_E1205-AO01 户外集装箱储能系统用户手册	文件编号: OLPSID-MU-25061601 Document number: OLPSID-MU-25061601	版本:V1.1 Version:V1.1	Page 31 of 106
---	---	-------------------------	----------------

6					
7					RS485-2-A
8					RS485-2-B

表 3.8.1-8 通讯接口板管脚定义

Table 3.8.1-8 Communication interface board pin definitions

PIN	1	2	3	4	5
	Cluster Address Binary address bits, a totally four bits, bit1 is for Lower bit and bit 4 is the higher bit, eg, The binary 1000 is the decimal address 1; The binary 0100 is the decimal address 2;				Termination resistor

表 3.8.1-9 通讯接口板拨码开关定义

Table 3.8.1-9 Communication interface board DIP switch definitions

PIN	1	2	3	4	5	6	7	8
定义 Defination	24V+	24V-	N/C	N/C	WDO+	WDO-	CANH	CANL

表 3.8.1-10 BATT COM 连接器管脚定义

Table 3.8.1-10 BATT COM connector pin definitions

5) 电池簇 Battery cluster

由高压箱、15 个电池包和连接电缆组成一簇高压电池系统。

A cluster of high-voltage battery systems consisting of a HVbox, 15 battery packs, and connecting cables.

Item	Specification
电芯配置 Cell Configuration	1P240S
标称能量 Rated Energy	241kWh
工作电压 Operating Voltage	672~864Vdc
额定充放电电流 Rated charge/discharge current	157A
最大充放电电流 Max charge/discharge current	157A



表 3.8.1-11 电池簇技术参数
Table 3.8.1-11 Technical Parameters of Battery Clusters

6) 电池管理系统 Battery Management System

电池管理系统分为 2 个级别：BMU 和 BSU。

Battery management systems are categorized into 2 levels: BMU and BSU.

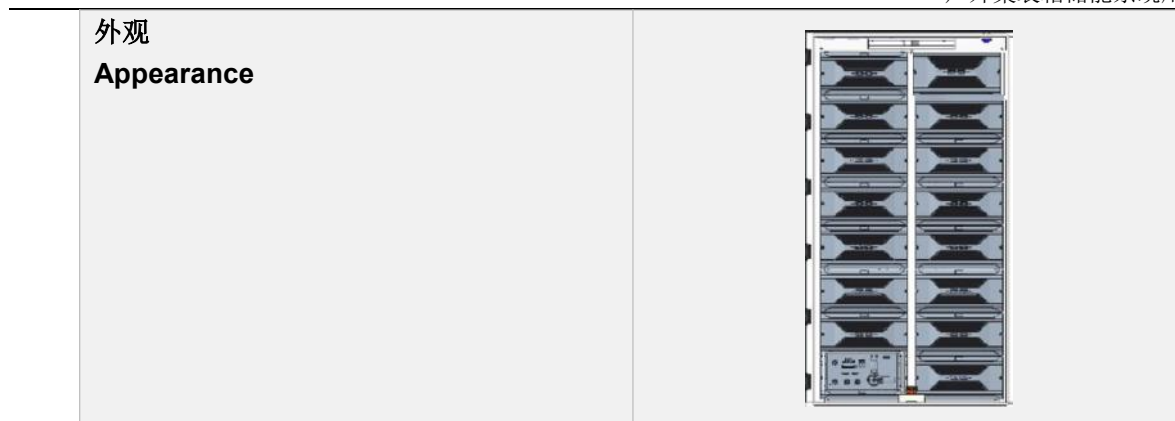
BSU 安装在电池箱，负责采集电池箱内电池单体数据，并上传。

The BSU is installed in the battery box and is responsible for collecting data from the battery cells in the battery box and uploading it.

BMU 安装在高压控制箱，负责接收并处理 BSU 上传的电池单体电压和温度数据，电流互感器数据，以及 SOC 计算和校正，执行电流，电压，温度等各级逻辑保护。

The BMU is installed in the high-voltage control box and is responsible for receiving and processing the battery cell voltage and temperature data uploaded by the BSU, the current transformer data, as well as SOC calculations and corrections, and executing all levels of logic protection such as current, voltage, and temperature.

序号 NO.	条目 Item	规格参数 Specification
1	工作电压 Supply voltage	24Vdc
2	单体电压采样精度 Individual voltage sampling accuracy	±5mV
3	总电压采样精度 Total voltage sampling accuracy	1%FSR
4	总电压采样范围 Total voltage sampling range	0~1500Vdc
5	电流采样精度 Current sampling accuracy	1%RDG
6	电流采样范围 Current sampling range	-200~+200A
7	温度采样精度 Temperature sampling accuracy	±2°C

OLP EC-PV650_P500_E1205-AO01 户外集装箱储能系统用户手册	文件编号: OLPSID-MU-25061601 Document number: OLPSID-MU-25061601	版本:V1.1 Version:V1.1	Page 33 of 106
---	---	-------------------------	----------------

8	SOC 准确度 SOC accuracy	≤5%
---	-------------------------	-----

表 3.8.1-12 电池管理单元

Table 3.8.1-12 Battery Management Unit



图 3.8.1-13 电池管理单元拓扑图

Figure 3.8.1-13 Topology diagram of battery management unit

3.8.2. 储能变流器 (PCS) Power Conversion System (PCS)

1) 储能系统介绍 Introduction of energy storage system

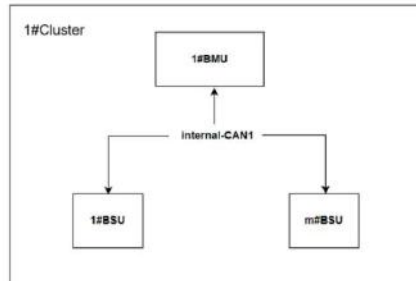
储能系统(Energy Storage System,简称 ESS)储能即能量存储,是指通过一种介质或者设备把一种能量形式用同一种或者转换成另一种能量形式存储起来,基于未来应用需要以特定能量形式释放出来的循环过程。储能系统是电网“发-输-变-配-用”环节的重要组成部分,是能源互联网和智慧能源的必不可少的组成部分。

Energy Storage System (ESS) refers to the cycle process of storing the same form of energy or converting it into another form of energy through a medium or device. and releasing it in a specific form of energy based on future applications. Energy storage system is an important part of the power grid link "power-transmission-convert-distribution-use", is an essential part of the Energy Internet and smart energy.

发电侧:储能系统可以参与快速响应调频服务,提高电网备用容量,并且可将如风能、太阳能等可再生能源向终端用户提供持续供电,扬长避短地利用了可再生能源清洁发电的优点,也有效地克服了其波动性、间歇性等缺点。

Generation: The energy storage system can participate in the rapid response frequency modulation service, improve the reserve capacity of the power grid, provide continuous power supply to the end users with wind energy, solar energy and other renewable energy. Furthermore, it makes use of the advantages of renew able energy, and also effectively overcome its shortcomings such as volatility and intermittency.

输配环节:储能系统可以有效地提高输电系统的可靠性,提高电能的质量。

Transmission and distribution: Energy storage system can effectively improve there liability of transmission system and improve the quality of electric energy.

用户侧:分布式储能系统在智能微电网能源管理系统的协调控制下优化用电,降低用电费用并且保持电能的高质量。

User: The distributed energy storage system optimizes electricity consumption, reduces electricity costs and maintains the high quality of electric energy under the coordinated control of the intelligent

OLP EC-PV650_P500_E1205-AO01 户外集装箱储能系统用户手册	文件编号: OLPSID-MU-25061601 Document number: OLPSID-MU-25061601	版本:V1.1 Version:V1.1	Page 34 of 106
---	---	-------------------------	----------------

microgrid energy management system.

在 ESS 中主要通过混合逆变器(Hybrid inverter)来实现电能的变换，如下图 3.8.2-1 所示：

In the ESS, the energy conversion is mainly realized by the power conversion system (PCS), as shown in Figure 3.8.2-1:



图 3.8.2-1 混合逆变器在 ESS 中的应用场景

Figure 3.8.2-1 Application scenarios of Power Conversion System in ESS

2) 产品外观 Product appearance

产品外观和外部组件如下图所示：

The appearance and external components of Power Conversion System as shown below:



图 3.8.2-2 PCS 外观图

Figure 3.8.2-2 Appearance of 1 PCS



LCD screen

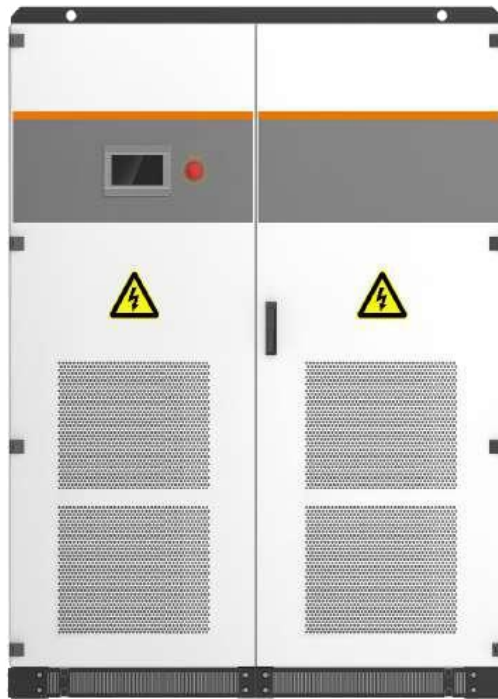
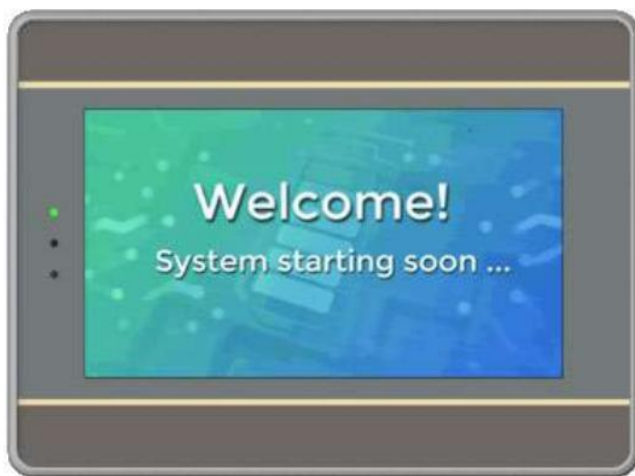

Emergency Power Off Button

图 3.8.2-3 LCD 屏幕&急停按钮

Figure 3.8.2-3 Screen & Emergency Power Off Button

3) 系统原理图 System schematic diagram



图 3.8.2-4 PCS 系统原理图

Figure 3.8.2-4 PCS System schematic diagram

4) 基本功能 Basic Function

并网 On-grid

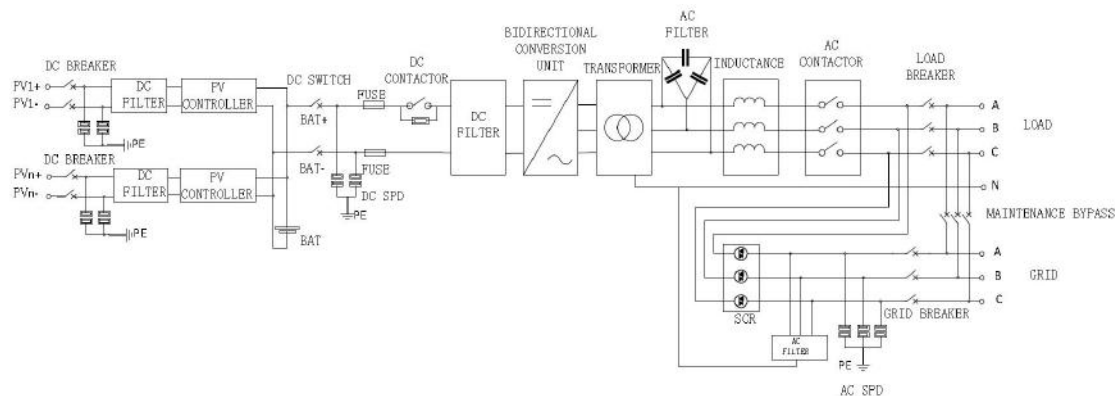
混合逆变器直接连接到电网，既可以通过电池向电网输出能量，也可以从电网吸收能量给电池充电。

The converter is directly connected to the grid and can either output energy to the grid through the battery or absorb energy from the grid to charge the battery.

离网 Off-grid

在没有电网的情况下，储能逆变器可以独立运行，提供负载电源。

In the absence of grid, the Power Conversion System can operate independently to provide load power supply.

并网/离网切换 On-grid/off-grid switch

该功能仅适用于支持并网/离网切换的模型。在并网模式下，储能逆变器不进入待机状态，直接切换充放电状态。储能逆变器在没有电网的情况下实现独立逆变。

The function is only for models that support on-grid/off-grid switch. In the on-grid mode, the Power Conversion System directly switches the charging and discharging state without entering the standby state. The Power Conversion System operates independent inversion in the absence of the grid.

储能电池充放电控制 Charge and discharge control of energy storage battery

PCS 系列所有型号的储能逆变器均能在并网模式下充放电。

The Power Conversion System of all PCS series models are capable of charging and discharging in on-grid mode.

充放电深度可由用户自行设定。

The depth of charge and discharge can be set by the user.

5) 低电压穿越能力 Low voltage ride through capability

当电站接点电压降至 0 时，电站应能连续运行 0.15s 而不脱网。

When the voltage of the power station junction drops to 0, the power station should be able to run continuously for 0.15s without taking off the grid.

OLP EC-PV650_P500_E1205-AO01 户外集装箱储能系统用户手册	文件编号: OLPSID-MU-25061601 Document number: OLPSID-MU-25061601	版本: V1.1 Version: V1.1	Page 37 of 106
---	---	---------------------------	----------------

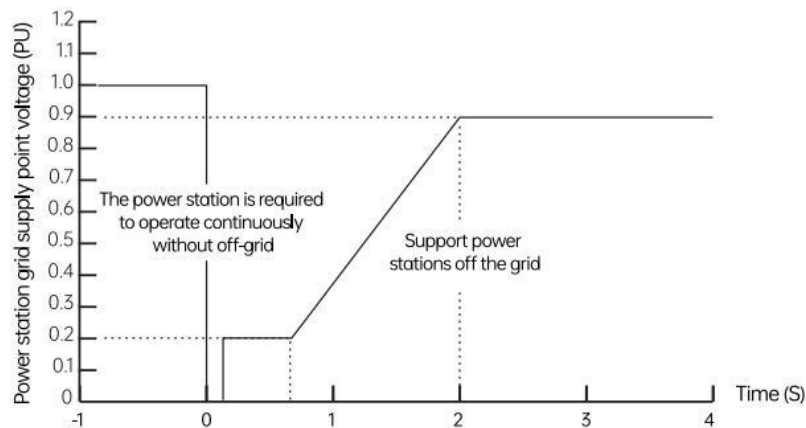

* This series converter meets the above requirements.

图 3.8.2-5 低电压穿越能力

Figure 3.8.2-5 Low voltage ride through capability

6) 混合逆变器状态 Status of converter (MPS)

状态 Status	描述 Description
工作 Operation	混合逆变器正常工作 Converter works normally.
故障 Fault	当储能系统出现故障时，混合逆变器会停止工作，自动将交直流侧的接触器断开，主电路与电池、电网或负载脱离。 故障状态下，系统一直监测故障是否消除，如果故障未消除，则保持故障状态；如果故障消除，默认 30 秒以后进入关机状态。 When the energy storage system malfunctions, the converter will stop working and automatically disconnect the AC-DC contactor, then the main circuit is separated from the battery, the power grid or the load. In the fault state, the system keeps monitoring whether the fault is rectified. If the fault is not rectified, the system keeps the fault state. If the fault is rectified, the system shuts down after 30 seconds by default.
停止 Halt	若混合逆变器处于正常的“运行”状态，用户可通过上位机发出停机指令来使混合逆变器停止工作，或者通过 LCD 屏开关机页面的关机键关机。 When the Power Conversion System is in the operation state, the user stops the Power Conversion System by issuing a stop command through the upper computer, or shut down the Power Conversion System through the shutdown button on the LCD screen switching page.
紧急停止 Emergency halt	在故障或紧急情况下，按 EPO 按钮停止混合逆变器。 In case of failure or emergency, press the EPO button to stop the converter.

表 3.8.2-6 混合逆变器状态

Table 3.8.2-6 Status of converter

OLP EC-PV650_P500_E1205-AO01 户外集装箱储能系统用户手册	文件编号: OLPSID-MU-25061601 Document number: OLPSID-MU-25061601	版本:V1.1 Version:V1.1	Page 38 of 106
---	---	-------------------------	----------------

7) PCS 参数表 PCS parameter table

序号 NO.	参数名称 Parameter name	参数值 Parameter value
交流(并网) AC(On-Grid)		
1	最大输出功率 Maximum output power	550KVA
2	额定功率 Rated power	500KW
3	额定电压 Rated voltage	400V
4	电压范围 Voltage range	320-460V
5	额定电流 Rated current	722A
6	额定频率 Rated frequency	50/60Hz
7	频率范围 Frequency range	45~55/55~65Hz
8	电流总谐波失真 Total harmonic distortion of current	<3%
9	功率因数 Power factor	1超前~1滞后 1leading~1lagging
10	交流制式 Communication format	三相四线+地线(3W+N+PE) Three-phase four-wire + ground wire (3W+N+PE)
交流（离网） DC(OFF-Grid)		
11	额定输出功率 Rated output power	500KW
12	最大输出功率 Maximum output power	550KW
13	额定输出电压 Rated output voltage	400V
14	额定输出电流 Rated output current	722A
15	THDU	≤1%线性; 或≤5%非线性 ≤1% linear; Or ≤5% nonlinear
16	额定输出频率 Rated output frequency	50/60Hz

OLP EC-PV650_P500_E1205-AO01 户外集装箱储能系统用户手册	文件编号: OLPSID-MU-25061601 Document number: OLPSID-MU-25061601	版本:V1.1 Version:V1.1	Page 39 of 106
---	---	-------------------------	----------------

17	过载能力 Overload capacity	110%长期, 120%1 分钟 110% for a long time, 120% for 1 minute
系统参数 System parameters		
18	尺寸 W*D*H Dimensions: W*D*H	1600*1050*2050mm
19	重量 Weight	3325kg
20	工作温度 Working temperature	-30~55°C
21	湿度 Humidity	0~95% (无凝露) 0~95% (No condensation)
22	防护等级 IP Rating	IP20
23	噪音 Noise	<70db
24	海拔 Latitude	5000m (>300m 降容) 5000m (>300mCapacity reduction)
25	冷却方式 Cooling method	风冷 Air-cooled

表 3.8.2-7 PCS 参数

Table 3.8.2-7 PCS parameter

8) 试运行 Trial operation

开机前检查

Check before starting

在试运行之前, 彻底的检查设备的安装情况, 应该特别检查直流和交流端的电压是否符合混合逆变器的要求, 以及极性、相序是否正确等。

Before commissioning, a thorough inspection of the installation of the equipment should be carried out, especially to check whether the DC and AC voltages meet the requirements of the converter, as well as whether the polarity and phase sequence are correct.

检查所有连接是否都已经符合相关标准规范的要求。并且系统是否良好接地。接地电阻对于整个系统安全具有重要意义, 必须在首次试运行之前确定接地电阻符合要求。

Check that all connections have met the requirements of the relevant standards and specifications. And whether the system is well grounded. Grounding resistance is of great importance to the safety of the whole system. It must be determined that the grounding resistance meets the requirements before the first trial operation.

试运行前需要确保直流, 交流侧所有开关均为断开状态。

Before trial operation, ensure that all switches on the DC and AC sides are in the off position.

步骤 1: 检查混合逆变器

Step 1: Check the converter

OLP EC-PV650_P500_E1205-AO01 户外集装箱储能系统用户手册	文件编号: OLPSID-MU-25061601 Document number: OLPSID-MU-25061601	版本:V1.1 Version:V1.1	Page 40 of 106
---	---	-------------------------	----------------

混合逆变器需要在开机前进行检查。

The converter needs to be checked before it is turned on.

确认所有交流、直流空开都处于断开状态

Ensure that all Ac and Dc air cui breakers are disconnected.

步骤 2: 检查交流侧电压

Step 2: Check Ac side voltage

检查变流器三相与电网三相是否连接正确。

Check whether the three phases of the converter are connected correctly to the three phase of the power grid.

检查相电压和线路电压是否在预定范围内，并记录电压值。

Check whether the phase voltage and line voltage are within the predetermined range and record the voltage value.

如果可能，测量总谐波失真（THD）并查看曲线。如果失真严重，混合逆变器可能无法工作。

If possible, measure the total harmonic distortion (THD) and view the curve. If the distortion is severe, the hybrid inverter may not work.

步骤 3: 检查直流侧电压

Step 3: Check DC side voltage

直流侧应连接到电池组的逆变器上，确保每个电池组的输入极性正确。

The DC side should be connected to the converter from the battery pack to ensure that the input polarity of each battery pack is correct.

光伏侧应从 PV 输入连接混合逆变器，确保每组 PV 输入极性正确。

The PV side should be connected to the hybrid inverter from the PV input, ensuring that the polarity of each PV input is correct.

电池最高电压不得超过 850V。

The Battery side voltage shall be exceed 850V.

光伏最高电压不得超过 1000V。

The maximum voltage of photovoltaic power shall not exceed 1000V.

如果电压偏差大于 3%，可能是由于负载波动、电缆损坏或电缆松动造成的。

If the voltage deviation is greater than 3%, it may be caused by load fluctuation, cable damage or cable loosening on site.

步骤 4: 完成上述检查后再检查其他内容。以下项目需要仔细检查，确保正确无误。

Step 4: Check other content after completing the above check before starting. the following items need to be carefully checked to ensure that they are correct.

设备内部防护罩安装牢固。

The protective shield inside the equipment has been firmly installed.

紧急关机按钮被释放。

The emergency shutdown button is released.

交流侧和直流侧断路器已断开，处于“OFF”位置。

The AC side and DC side circuit breakers have been disconnected, they are in the "OFF" position.

万用表用于检测交流、直流侧电压是否满足变流器启动条件，有无过压危险。

The multimeter is used to detect whether the AC and DC side voltages meet the starting conditions of the converter, and there is no danger of overvoltage.

OLP EC-PV650_P500_E1205-AO01 户外集装箱储能系统用户手册	文件编号: OLPSID-MU-25061601 Document number: OLPSID-MU-25061601	版本:V1.1 Version:V1.1	Page 41 of 106
---	---	-------------------------	----------------

柜门已关闭，柜门钥匙已拔出，交由专人保管。

The door of the cabinet has been closed and the key of the cabinet door has been pulled out and handed over to a special person for safekeeping.

对于长时间停机的混合逆变器，在启动前，必须对设备进行彻底、细致的检查，确保各项指标符合启动前的要求。

For the long downtime Power Conversion System, before starting, the equipment must be thoroughly and meticulously checked to ensure that all indicators meet the requirements before starting.

9) 开机操作流程 Start-up operation

满足以上条件后，即可启动混合逆变器。

After all the above items are satisfied, the Power Conversion System can be started up.

操作步骤如下：

The operation steps are as follows:

步骤 1：确认直流侧和交流侧连接正确，直流侧电压低于 850v。

Step 1: Make sure that the DC side and AC side are connected correctly and the DC side voltage is lower than 850v.

步骤 2：闭合交流和直流断路器开关。

Step 2: Close AC and DC circuit breaker switches.

步骤 3：合上防雷开关 KS、辅助电源开关 KB1、接触器电源开关 KB2（并网和离网一体化型号需合上 KB3）。

Step 3: Close the lightning protection switch KS, auxiliary power switch KB1, contactor power switch KB2, (and on-grid and off-grid integrated models need to close KB3).

步骤 4：完成以上步骤后，通过触摸屏上的开关菜单点击混合逆变器打开。机器正常开机后，可通过触摸屏查看机器运行状态。

Step 4: After completing the above steps, click the converter to open through the switch menu on the touch screen. The running status of the machine can be checked through the touch screen after the machine is turned on normally.

步骤 5：机器正常运行后，关闭柜门，将钥匙交给专人保管；详细开机步骤如下：

Step 5: After the machine runs normally, close the cabinet door and hand over the key to a special person for safekeeping; The detailed startup steps are as follows:

- 确认光伏输入，闭合光伏输入开关后，若监控屏之前是黑屏的，此时监控屏会启动运行。（光伏送电时必须测量每路光伏，防止短路）。
- Confirm the photovoltaic input. After closing the photovoltaic input switch, if the monitoring screen was previously black, it will now start up and run. (When supplying photovoltaic power, each photovoltaic circuit must be measured to prevent short circuits.)

OLP EC-PV650_P500_E1205-AO01 户外集装箱储能系统用户手册	文件编号：OLPSID-MU-25061601 Document number: OLPSID-MU-25061601	版本:V1.1 Version:V1.1	Page 42 of 106
---	--	-------------------------	----------------



图 3.8.2-8 混合逆变器输入和输出

Figure3.8.2-8 Hybrid inverter input and output

- 将电池系统上电，合上电池开关。
- Power on the battery system and close the battery switch.
- 光伏输入和电池开机完成后，会听到光伏控制器内部有直流接触器闭合的声音（母线软起后直流接触器闭合声），之后在监控主界面的右下角显示的光伏控制器状态会有“关闭”变为“混合逆变器 x 待机”。
- After the photovoltaic input and battery startup are complete, you will hear the sound of the DC contactor closing inside the photovoltaic controller (the sound of the DC contactor closing after the busbar soft start). Subsequently, the status of the photovoltaic controller displayed in the lower right corner of the monitoring main interface will change from “Off” to “Hybrid Inverter x Standby.”
- 打开柜门，关闭 KB1、KB2、KB3，等待 30 秒左右，监控界面可显示电池电压数据。
- Open the cabinet door, close KB1, KB2 and KB3, wait about 30 seconds, the battery voltage data can be displayed on the monitoring interface.

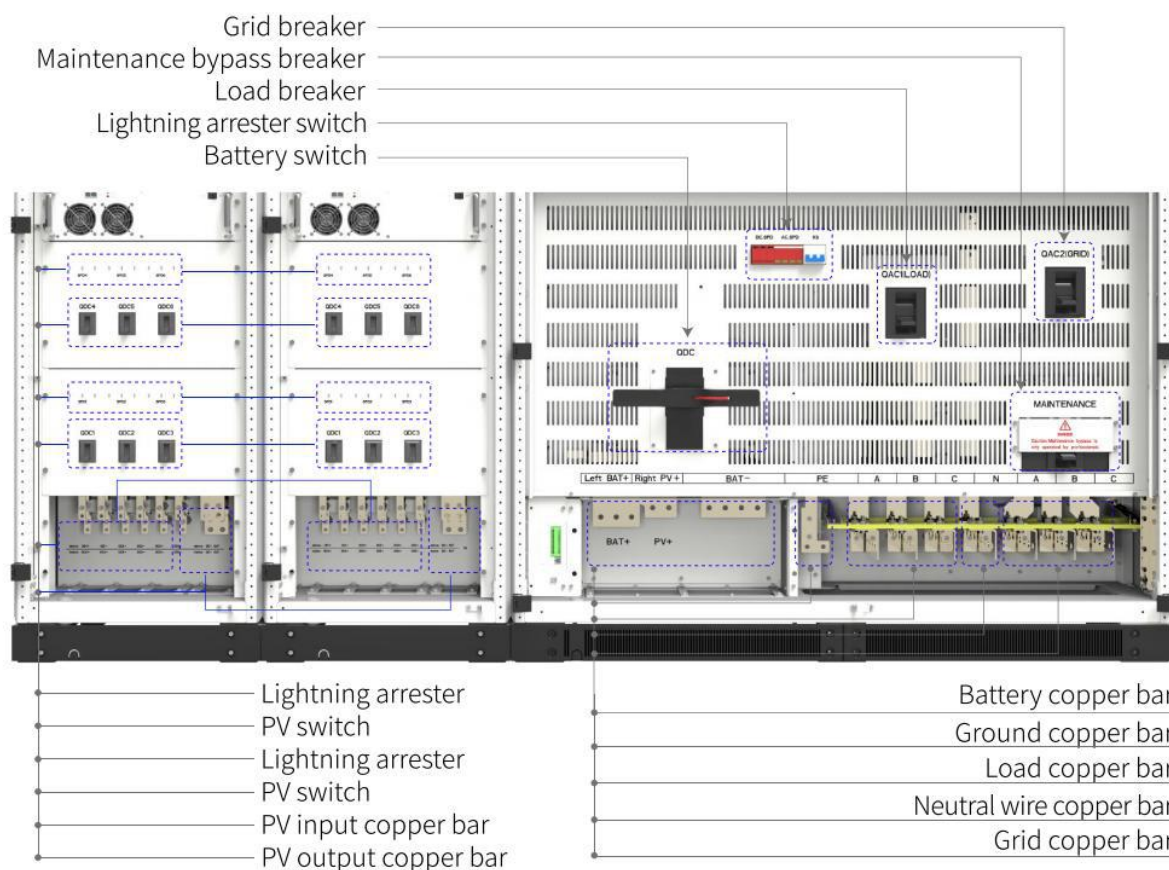
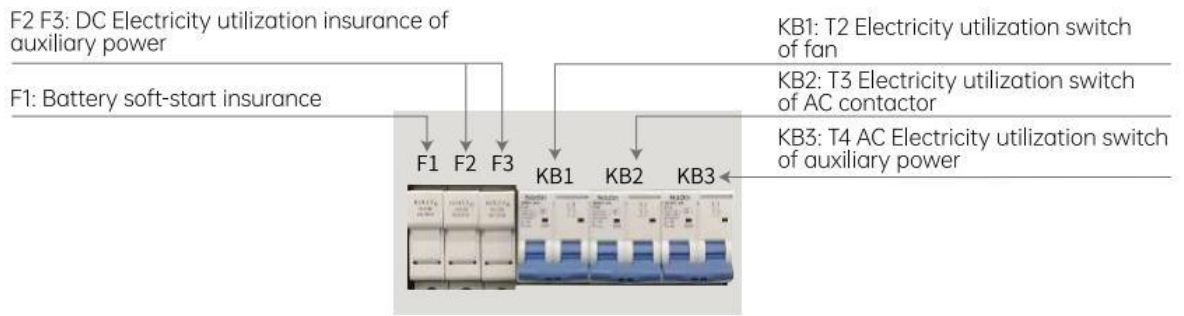

• 图 3.8.2-9 内部微断

Figure 3.8.2-9 Internal micro break

- 以“150kVA”为例，查看监控右上角是否有红色告警信号，在没有红色告警信号下即可开机。
- Take “150kVA” as an example, check whether there is a red alarm signal in the upper right corner of the monitor, and it can be turned on if there is no red alarm signal.
- 光伏控制器开机。点击监控左下角的“菜单”→“开关机”→“DCDC 变换器开启”。
- The photovoltaic controller is turned on. Click "Menu" → "Turn On/Off" → "DCDC converter ON" in the lower left corner of the monitor.

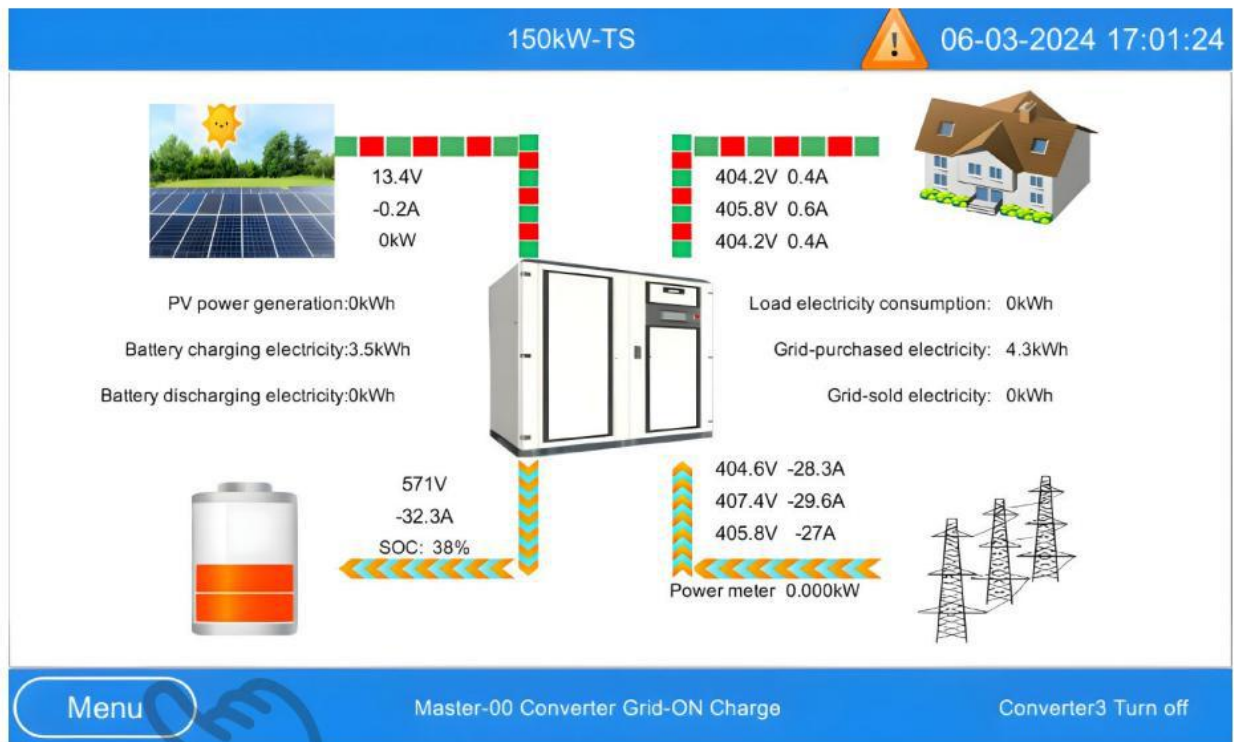

- 点击“DCDC 变换器开启”后在监控主界面的右下角显示的光伏控制器状态会有“待机”变为“混合逆变器 xMPPT”，此时光伏控制器正常运行。

- After clicking "DCDC converter ON", the PV controller status displayed in the lower right corner of the monitoring main interface will change from "Standby" to " Converter xMPPT", the PV controller is running normally.

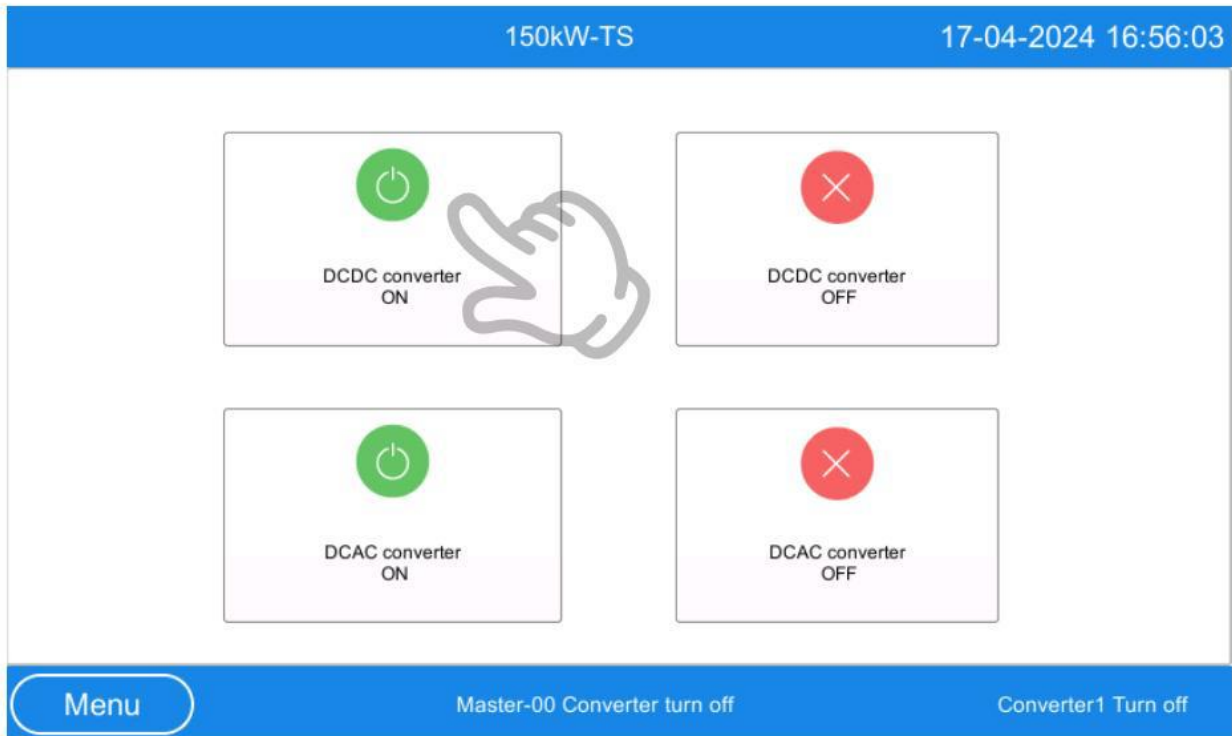

- 混合逆变器开机。点击监控左下角的“菜单”→“开关”→“DCAC 混合逆变器开启”。
- The converter starts. Click "Menu" → "Turn On/Off" → "DCAC converter ON" in the lower left corner of the monitoring.

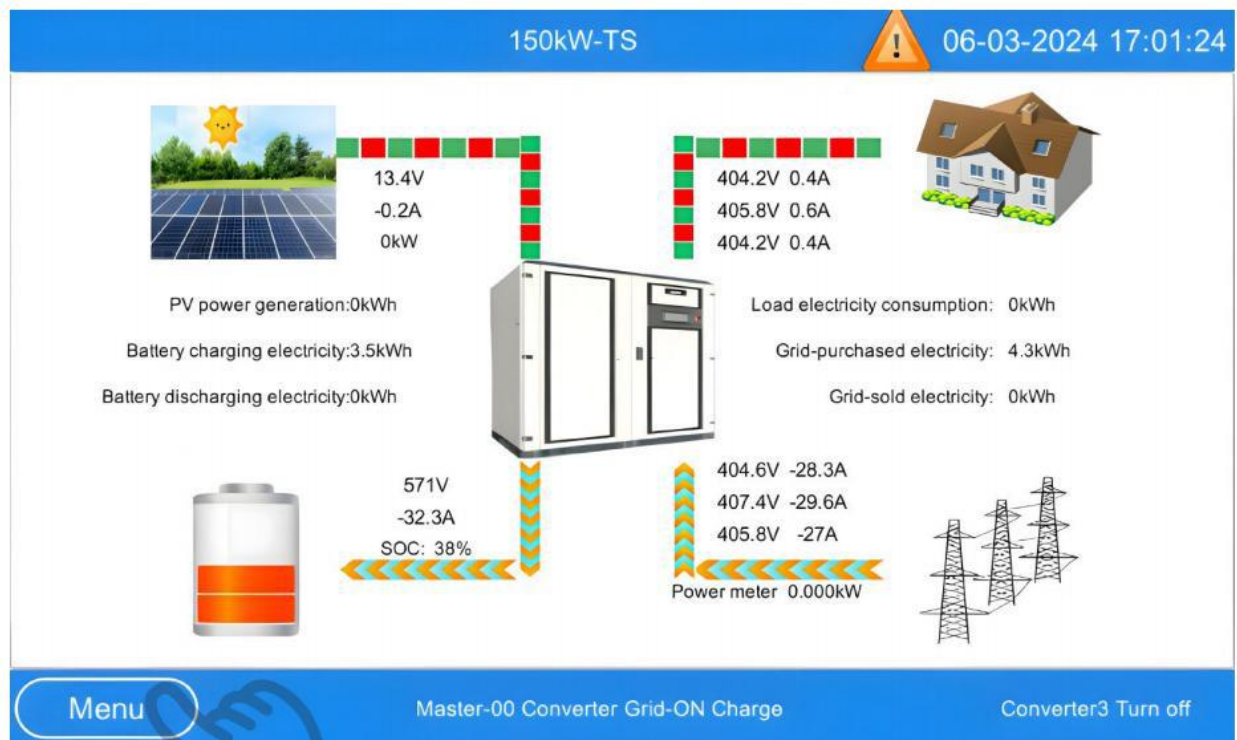

- 点击“DCAC”混合逆变器开启”后会听到直流接触吸合声音，而后混合逆变器软起，软起完成后会听到交流接触器吸合声音，此时在监控主界面的正下角显示的混合逆变器状态会有变为“混合逆变器离网放电”或“混合逆变器并网充电”或“混合逆变器并网放电”。此时混合逆变器正常运行。
- After clicking "DCAC converter ON", you will hear the DC contact suction sound, and then the converter will soft up. After soft up, you will hear the AC contactor suction sound. At this time, the converter state displayed at the positive lower Angle of the monitoring main interface will change to "converter off-grid discharge" or "converter grid-connected charging" or "converter grid-connected discharge". At this time, the converter runs normally.

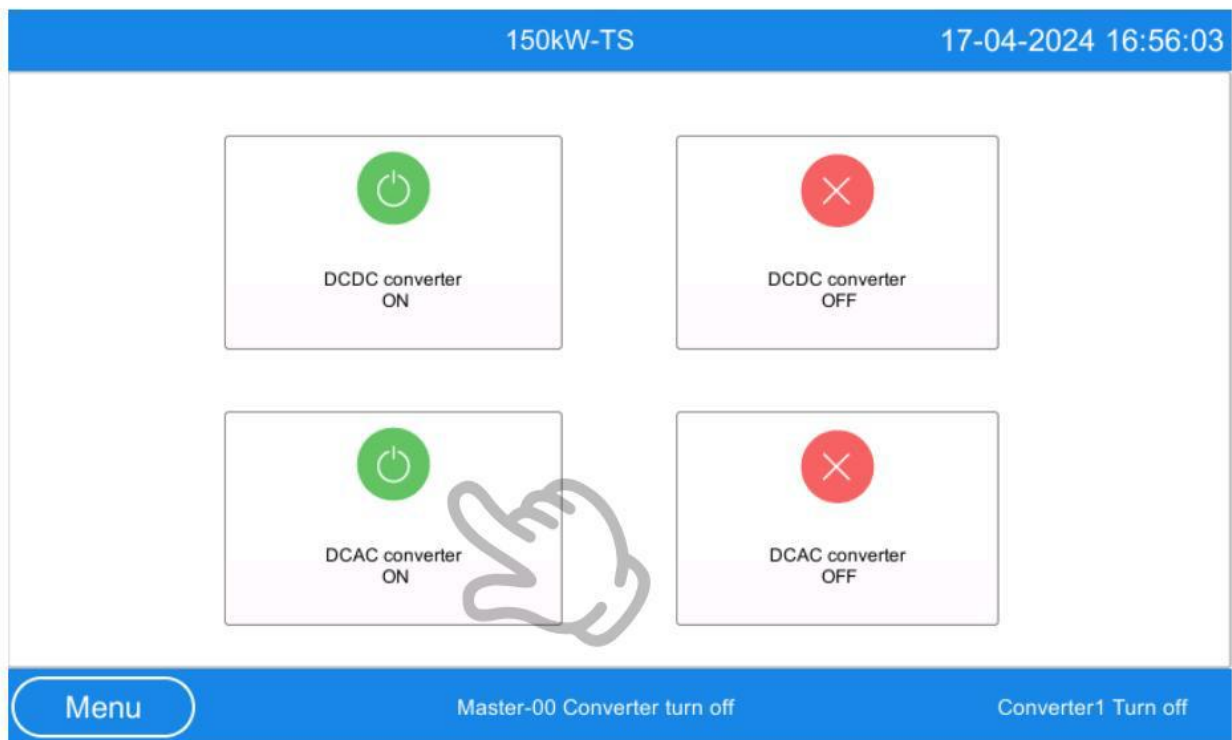

- 到此，混合逆变器开机完成。
- At this point, the hybrid inverter startup is complete.

10) 停机操作 Shutdown operation

正常关闭

Normal shutdown

正常保养或检修时，应按下列程序进行停机操作：

During normal maintenance or overhaul, shutdown operation should be carried out according to the following procedures:

步骤 1：通过触摸屏上的菜单，点击“关闭”。

Step 1: Through the menu on the touch screen, click "Turn off".

步骤 2：待交流接触器断开，触摸屏显示“变流器”闭合后，手动断开变流器直流侧断路器或负载开关，使其处于“OFF”状态。

Step 2: After the AC contactor is disconnected and the touch screen displays "converter" is closed, manually disconnect the DC side circuit breaker or load switch of the converter to make the switch in the "OFF" status.

步骤 3：断开变流器风扇开关，断开辅助电源开关，断开防雷开关。

Step 3: Disconnect the converter fan switch, disconnect the auxiliary power switch and disconnect the lightning protection switch.

步骤 4：断开混合逆变器的交流侧断路器，使开关处于“OFF”状态。

Step 4: Disconnect the AC side breaker of the converter so that the switch is in the "OFF" status.

步骤 5：等待母线电容放电，触摸屏熄灭，混合逆变器关机。

Step 5: Wait for the bus capacitor to discharge, the touch screen to go off, and the Power Conversion

OLP EC-PV650_P500_E1205-AO01 户外集装箱储能系统用户手册	文件编号: OLPSID-MU-25061601 Document number: OLPSID-MU-25061601	版本: V1.1 Version: V1.1	Page 47 of 106
---	---	---------------------------	----------------

System to shut down.

机器正常工作时，严禁直接断开断路器，以免电弧损坏断路器。

When the machine is working normally, it is strictly forbidden to disconnect the circuit breaker directly, so as to avoid dangerous arc damage to the circuit breaker.

严重时，还可能导致储能逆变器的损坏。

In severe cases, it may also lead to damage of Power Conversion System.

混合逆变器关闭详细步骤：

Converter shutdown Detailed steps:

光伏控制器的关机。点击监控左下角的“菜单”→“开关”→“DCDC 变流器关闭”，点击“DCDC 混合逆变器关闭”后在监控主界面的右下角显示的光伏控制器状态会有“混合逆变器 xMPPT”变为“待机”。此时光伏控制器停止工作。

Shutdown of the photovoltaic controller. Click on the “Menu” button in the lower left corner of the monitoring interface, then select ‘Switch’ → “DCDC Converter Off.” After clicking “DCDC Hybrid Inverter Off,” the status of the photovoltaic controller displayed in the lower right corner of the main monitoring interface will change from “Hybrid Inverter xMPPT” to “Standby.” At this point, the photovoltaic controller ceases operation.

混合逆变器关机。点击监控左下角的“菜单”→“开关”→“DCAC 混合逆变器关闭”，点击“DCAC 混合逆变器关闭”后会听到交流接触器断开声音，此时在监控主界面的正下角显示的混合逆变器状态会有变为“主机 -00 混合逆变器关闭”。此时混合逆变器停止工作。

Shut down the hybrid inverter. Click “Menu” in the lower left corner of the monitor → ‘Switch’ → “DCAC Hybrid Inverter Off.” After clicking “DCAC Hybrid Inverter Off,” you will hear the sound of the AC contactor disconnecting. At this point, the hybrid inverter status displayed in the lower right corner of the monitor's main interface will change to “Host -00 Hybrid Inverter Off.” The hybrid inverter will then stop operating.

发生故障或紧急情况时停机。

Shut down in case of malfunction or emergency.

如果发生紧急情况或故障，请按照以下步骤操作：

In case of emergency or malfunction, follow the following procedure:

步骤 1：按 EPO 按钮。

Step 1: Press the EPO button.

步骤 2：断开机器直流侧断路器或负载开关，交流侧断路器。

Step 2: Disconnect the machine DC side circuit breaker or load switch, AC side circuit breaker.

步骤 3：确认危险或故障已排除，需要操作工作后，复位 EPO 按钮。

Step 3: Reset the EPO button after confirming that the danger or fault has been removed and needs to be operated working.

EPO 按钮仅在机器故障或紧急情况下使用。正常关机时，根据触摸屏上的关机指示，通过触摸屏上的按钮进行关机操作。

紧急情况下，直接按 EPO 键，确保及时反应。

EPO button is only used in case of machine failure or emergency. When shutdown is normal, shutdown operation should be carried out through the button on touch panel according to the shutdown instruction on touch panel.

In case of crisis, press the EPO button directly to ensure prompt response.

OLP EC-PV650_P500_E1205-AO01 户外集装箱储能系统用户手册	文件编号：OLPSID-MU-25061601 Document number: OLPSID-MU-25061601	版本:V1.1 Version:V1.1	Page 48 of 106
---	--	-------------------------	----------------

3.8.3.MPPT

1) MPPT 模块 MPPT module

MPPT 模块可以将光伏产生的直流电变换为直流母线上所需的直流电，PCS 再将直流母线上的直流电逆变成为交流电。MPPT 模块不能作为 DC/DC 单独使用。

The MPPT module can convert the direct current generated by photovoltaic power into the direct current required on the direct current bus, and the PCS then inverts the direct current on the direct current bus back into alternating current. The MPPT module cannot be used alone as a DC/DC.



图 3.8.3-1 MPPT
Figure 3.8.3-1 MPPT

2) PMDE 机柜 PMDE cabinet

分体机采用 PMDE 机柜来装入多个 MPPT 模块。

The split machine uses PMDE cabinets to house multiple MPPT modules.

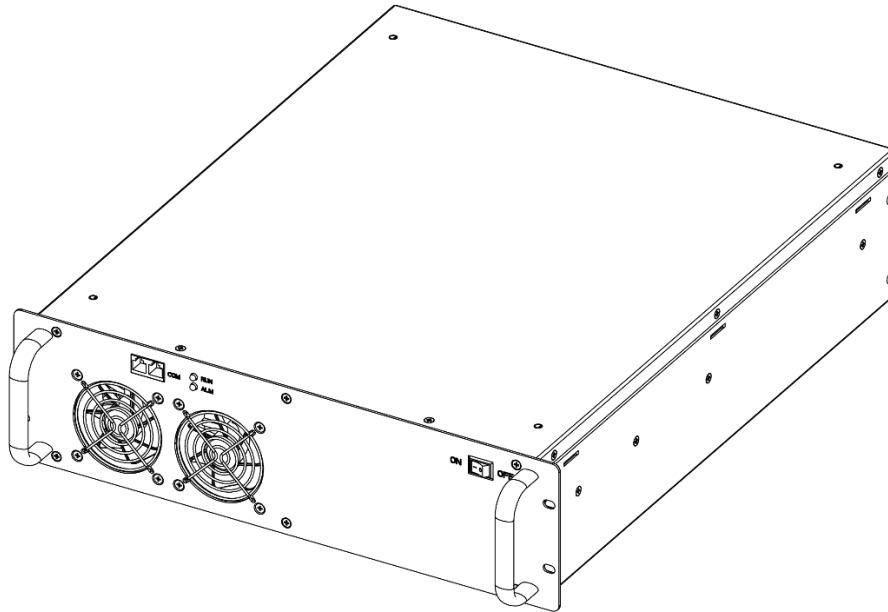
序号 NO.	参数名称 Parameter name	参数值 Parameter value
光伏输入参数 PV Input Parameters		
1	最大光伏输入电压 Max. PV in Put Voltage	1000V
2	光伏输入功率 PV Power	650KW
3	MPTT 模块数量 No. of MPPT	12
4	MPPT 工作电压范围 MPPT Voltage Range	250-850V
5	MPTT 满载电压范围	450-850V

	Full-load voltage range of MPTT	
--	---------------------------------	--



图 3.8.3-2 PMDE 柜
Figure 3.8.3-2 PMDE cabinet

3.8.4. 能量管理系统 EMS

能量控制器是一种嵌入式能量控制器。控制器从本地设备采集数据和信号，通过内部逻辑保证储能系统安全、可靠、经济地运行。控制器采用基于边缘计算的物联网架构，可通过后台或云系统下载决策模型，实现储能系统的智能化运行。该控制器具有峰谷套利、需求控制等多种控制方式。光伏和储能的互补性。

Energy controller is an embedded energy controller. The controller collects data and signals from local equipment and ensures the safe, reliable, and economic operation of the energy storage system through internal logic. Adopting the Internet of Things architecture based on edge computing, the controller can download decision-making models through the background or cloud system to achieve intelligent operation of the energy storage system. This controller has various control modes such as peak-valley arbitrage, demand control, and photovoltaic-storage complementarity.

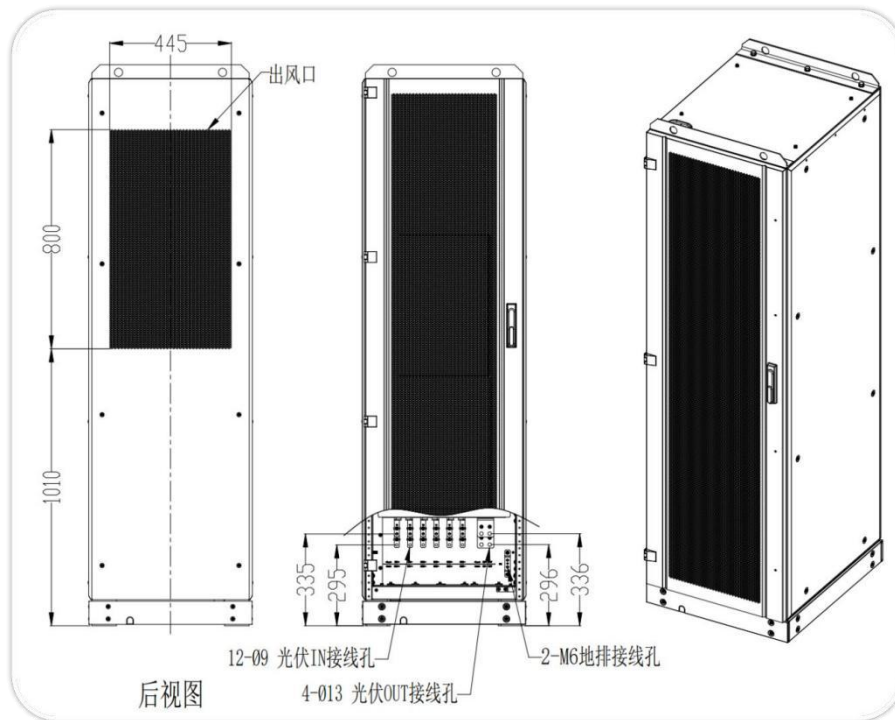

1) 系统功能 System Functions

功能 Function	描述 Description	
监控 Monitoring	SCADA	设备的数据显示, 包括拓扑图、状态、报警信息等 Data display of equipment, including topology diagrams, status, alert information, etc
	PCS	PCS 的模拟量、状态、实时数据、报警信息。 Analog, status, real-time data, and alert information of PCS.
	BMS	电池的模拟量、状态、信息、警报、SOC、SOH 等数据。 Analog, status, information, alerts, SOC, SOH, and other data of batteries.
	其他需求 Other Equipment	显示消防设备、环境监测设备等的信息。 Display of information from fire-fighting equipment, environmental monitoring equipment, etc.
报警 Alert	操作警报 Operational Alert	PCS 报警、电池报警等。 Alerts such as PCS alarms, battery alarms, etc.
	通信报警 Communication Alert	通信异常警报。 Communication anomaly alerts.
调度 Scheduling	多种调度策略 Multiple Scheduling Strategies	如调峰、稳态膨胀和瞬态膨胀等操作。 Operations such as peak shaving, steady-state expansion, and transient expansion.
日志 Log	PCS 日志 PCS Logs	记录 PCS 调测过程中产生的告警。 Recording of alarms generated during PCS commissioning.
	BMS 日志 BMS Logs	记录 BMS 调测过程中产生的告警。 Recording of alarms generated during BMS commissioning.
统计数据 Statistics	充电统计 Charging Statistics	今天, 这个月和今年的充电曲线 Charging curves for today, this month, and this year

OLP EC-PV650_P500_E1205-AO01 户外集装箱储能系统用户手册	文件编号: OLPSID-MU-25061601 Document number: OLPSID-MU-25061601	版本:V1.1 Version:V1.1	Page 51 of 106
---	---	-------------------------	----------------

	放电统计 Discharging Statistics	今天，这个月和今年的放电曲线 Discharging curves for today, this month, and this year.
	发电量统计数字 Power Generation Statistics	今天、本月和今年的发电量曲线 Power generation curves for today, this month, and this year.
	购电统计 Power Purchase Statistics	今天、本月和今年的购电曲线 Electricity purchase curves for today, this month, and this year
	售电统计数字 Power Sale Statistics	今天，这个月和今年的电力销售曲线 Electricity sale curves for today, this month, and this year
维护 Maintenance	远程升级 Remote Upgrade	pcs 远程升级，BMS 远程升级（可根据客户要求定制） Remote upgrade of PCS, remote upgrade of BMS (customizable according to customer requirements)
	远程调试 Remote Debugging	现场设备远程调试。 Remote debugging of on-site equipment
	远程修改参数 Remote Parameter Modification	远程修改设备设置参数 Remote modification of device setup parameters

2) 监控逻辑图 Monitoring menu Logic Diagram

OLP EC-PV650_P500_E1205-AO01 户外集装箱储能系统用户手册	文件编号: OLPSID-MU-25061601 Document number: OLPSID-MU-25061601	版本:V1.1 Version:V1.1	Page 52 of 106
---	---	-------------------------	----------------

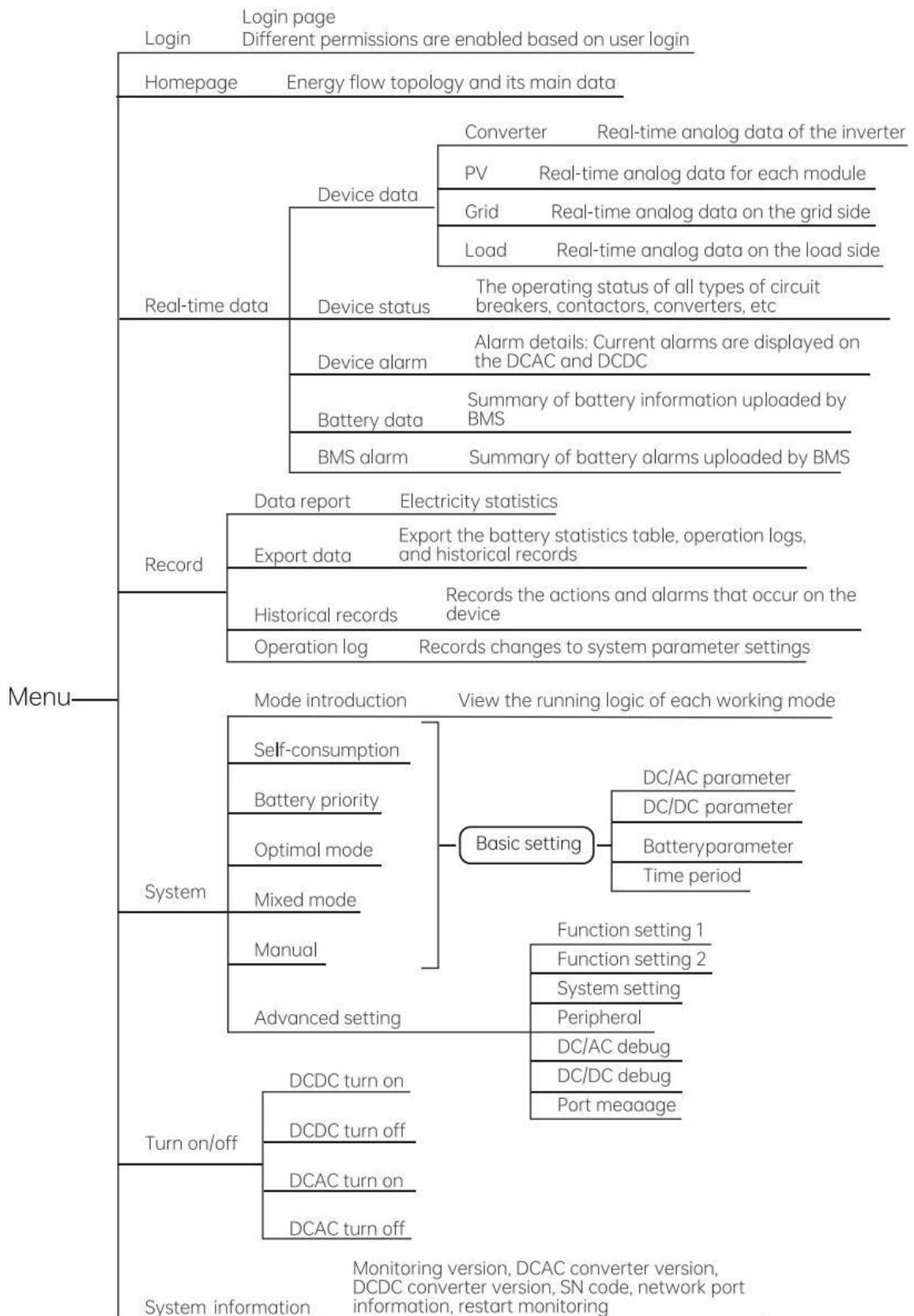

3) 触摸屏操作 Touch screen operation guidance

EMS 主页 EMS Homepage

主页分为三部分：The homepage is divided into three parts:

- 基本信息栏：包括机器型号、告警状态和时间设置按钮。点击时间按钮将打开时间设置界面，如图 3.8.6-3 所示，用户可以直接输入时分秒或使用按钮调整年月日。

Basic Information Bar: Includes machine model, alarm status, and a time setting button. Clicking the time button will open the time setting interface, as shown in Figure 3.8.6-3. Users can directly input hours, minutes, and seconds or use buttons to adjust the year, month, and day.

- 主页内容：显示混合逆变器、光伏、负载、电池以及电网的实时数据和电量数据，用户可以点击相应的图标按钮查看更详细的实时数据信息。

Homepage Content: Displays real-time data and power data for inverters, photovoltaics, loads, batteries, and the power grid. Users can click on the corresponding icon buttons to view more detailed real-time data information.

- 菜单栏：包括菜单按钮、DCAC 混合逆变器当前状态信息和 DCDC 模块当前的状态，点击菜单按钮跳转到系统菜单界面，如图 3.8.6-4 所示为菜单页面。

Menu Bar: Includes the menu button, current status information of the DCAC inverter, and the current status of the DCDC module. Clicking the menu button will jump to the system menu interface, with the menu page shown in Figure 3.8.6-4.



图 3.8.4-1 主页逻辑图

Figure 3.8.4-1 Home logic diagram

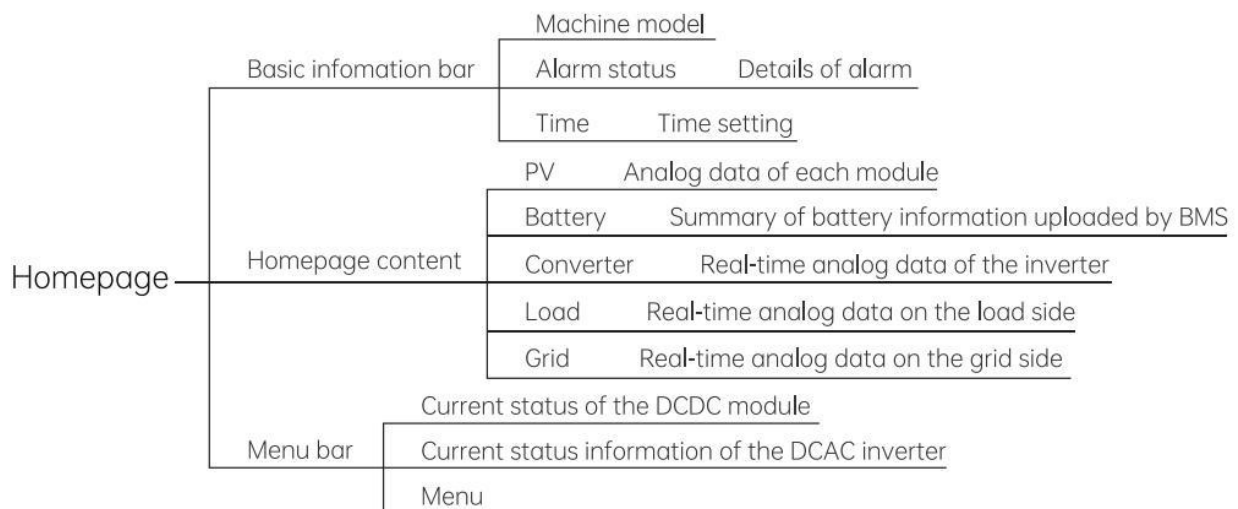
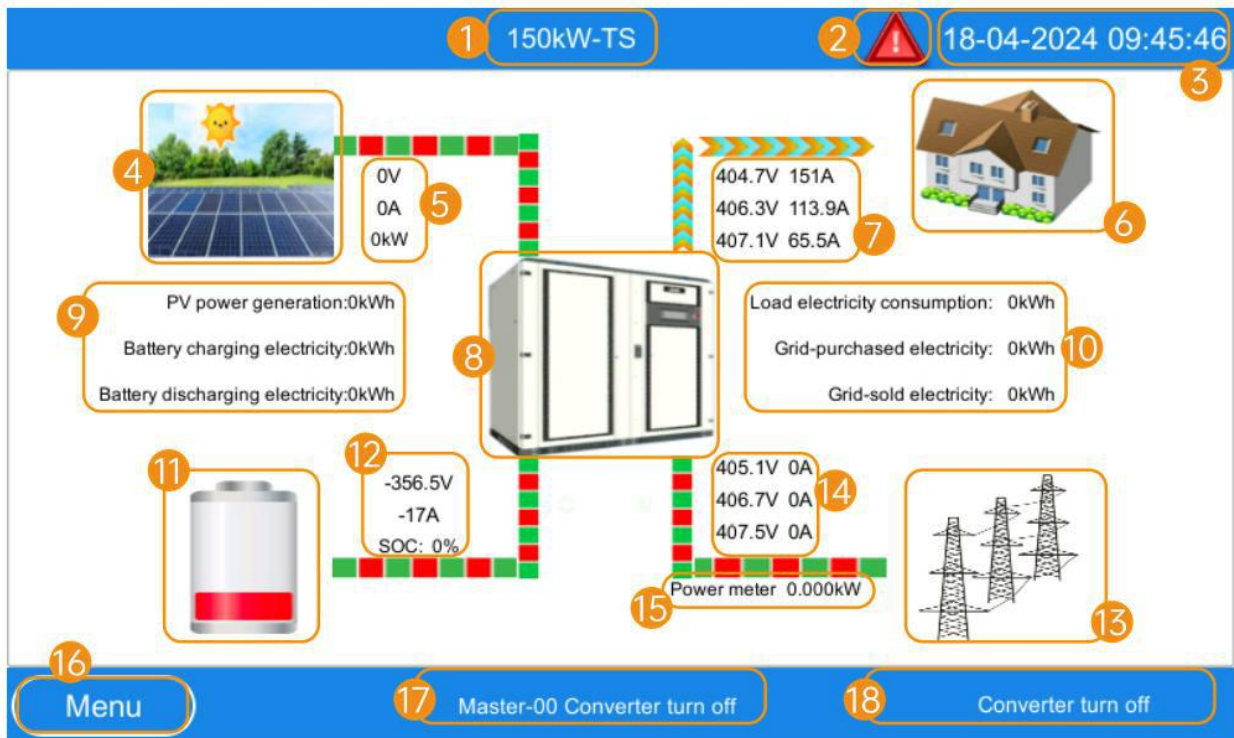

Homepage introduction

1. Machine model.
2. Alarm status: Click to view current alarms.
3. Time: Click to set the time.
4. Photovoltaics (PV): Click to jump to the real-time data interface, where you can view the real-time analog data of each module.
5. PV voltage value, current value, power value.
6. Load: Click to jump to the real-time data interface, where you can view the real-time analog data of the load.
7. Load voltage value, current value, power value .
8. Converter: Click to jump to the real-time data interface, where you can view the real-time analog data of the converter.
9. PV's daily power generation, battery's daily charge amount, battery's daily discharge amount.
10. Load's daily power consumption, grid's daily power purchase, grid's daily power sale.
11. Battery: Click to jump to the real-time data interface, where you can view the summary of battery data uploaded by the BMS.
12. Battery voltage value, battery current value, state of charge (SOC) value uploaded by BMS.
13. Grid: Click to jump to the real-time data interface, where you can view the real-time analog data of the grid.
14. Grid's phase A/B/C voltage and current values.
15. Power meter wattage.
16. Menu: Click to jump to the menu page.
17. Current status of the DCAC converter.
18. Current status of the DCDC converter.

图 3.8.4-2 主页界面介绍
Figure3.8.4-2 Time setting



图 3.8.4-3 时间设置
Figure3.8.4-3 Time setting



图 3.8.4-4 菜单页面
Figure3.8.4-4 Menu

菜单 Menu

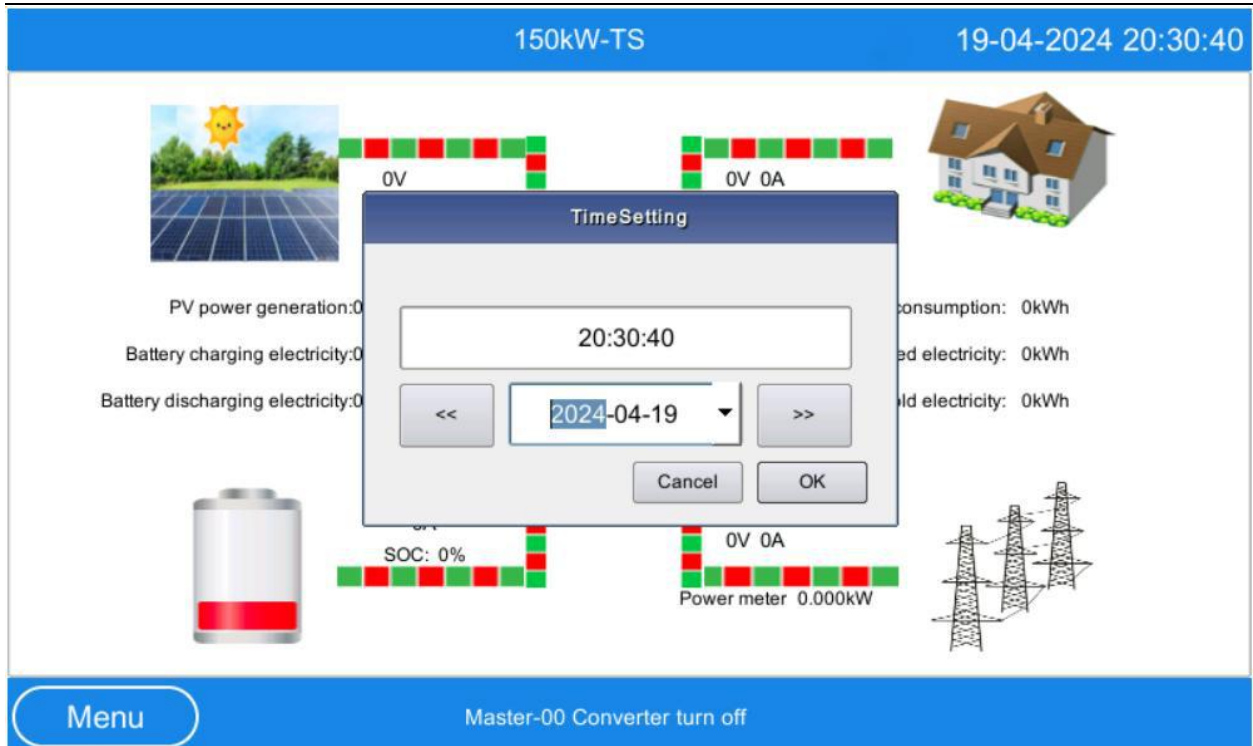
菜单界面由七个按钮组成，其分别是用户登录、主页、实时数据、记录、系统、开 / 关机、系统信息，点击菜单各个按钮将跳转到相应界面，如图 3.8.6-5，3.8.6-6 所示。

The menu interface consists of seven buttons, which are: Login, Homepage, Real-Time Data, Records, System, Turn On/Off, and System Information. Clicking each button will redirect to the corresponding interface, as shown in Figures 3.8.6-5 and 3.8.6-6.

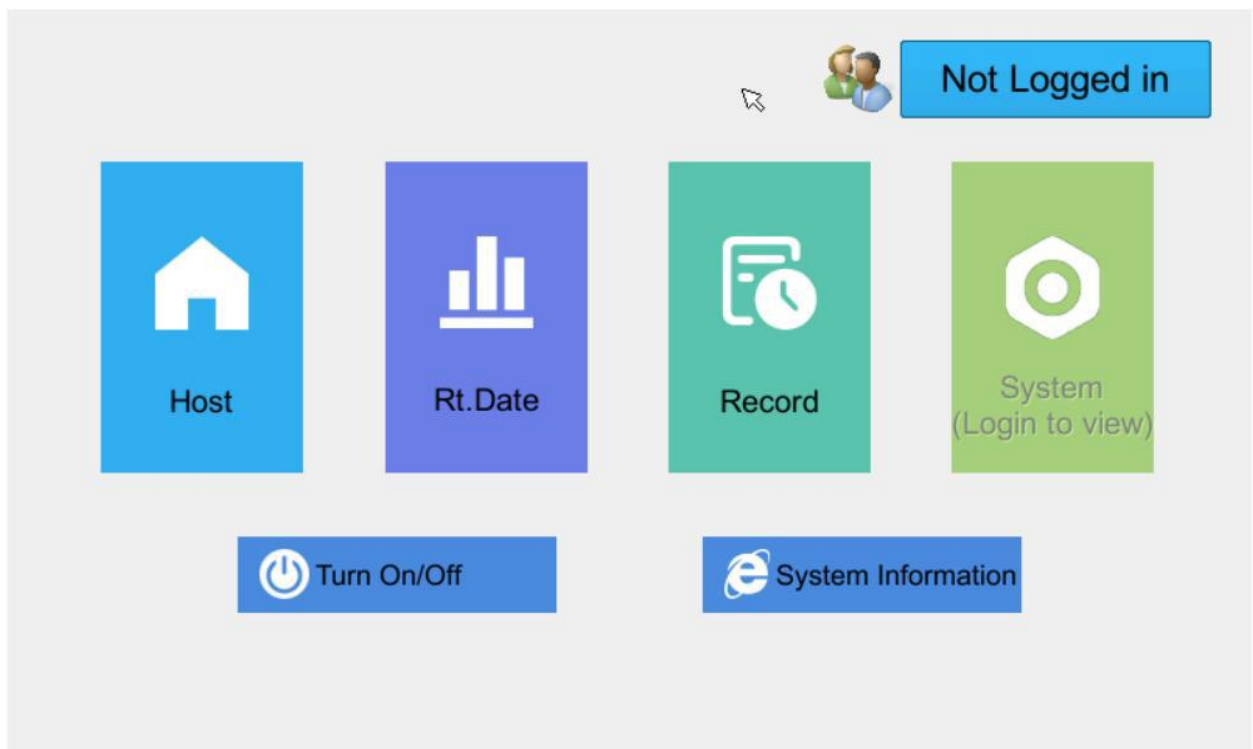

图 3.8.4-5 菜单逻辑图

Figure 3.8.4-5 Menu logic diagram

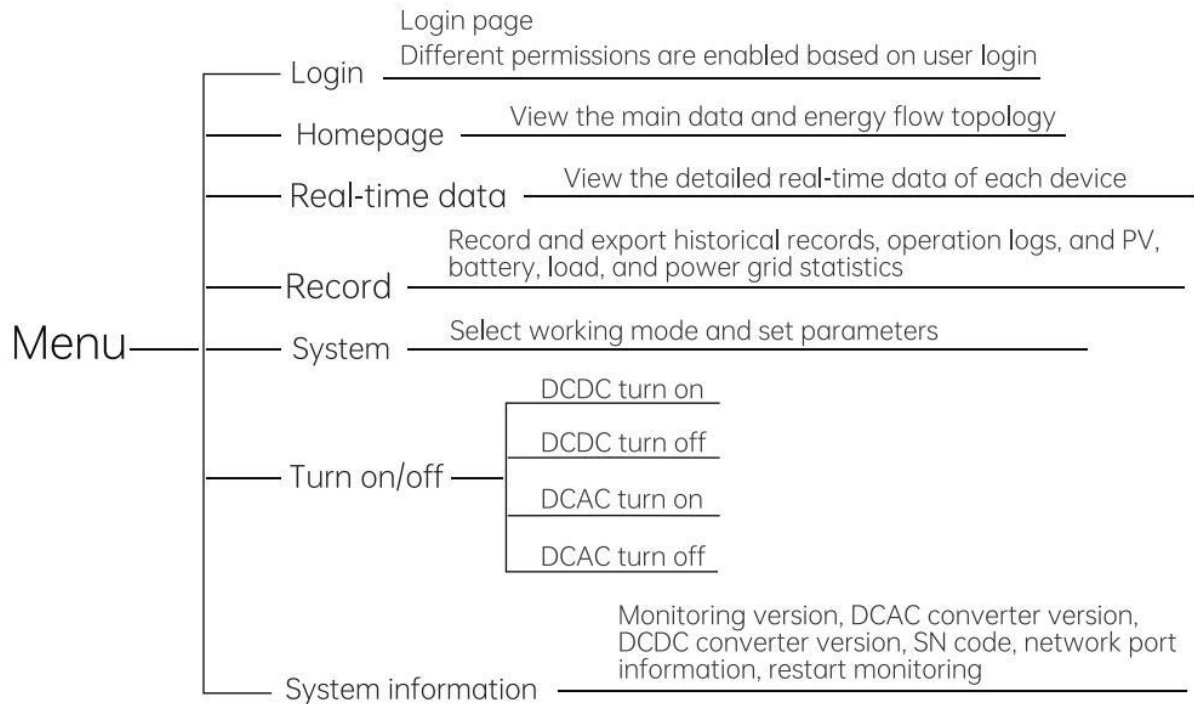
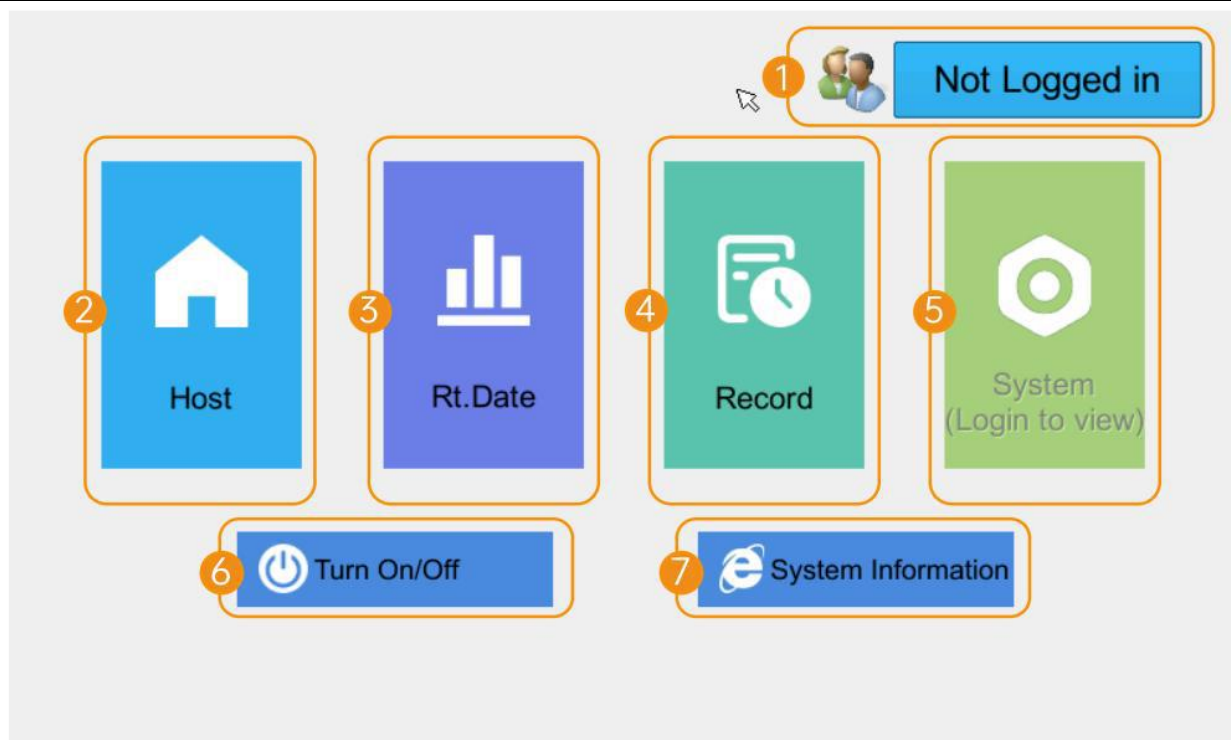

Menu page introduction

1. Login: Click to navigate to the login page, which offers different permissions based on the user type.
2. Homepage: Click to return to the homepage.
3. Real-Time Data: Navigate to the real-time data page to view analog data for inverters, photovoltaics, the grid, and loads. This includes the operational status of various devices like circuit breakers, contactors, inverters, battery data uploaded by the BMS, and device alarms.
4. Record: Record and export historical records, operation logs, and statistics of electricity for PVs, batteries, loads, and the grid.
5. System: Choose the working mode and set related parameters as needed.
6. Turn On/Off: Access the on/off interface to independently control the operation of the DCAC and DCDC converters.
7. System Information: View monitoring version, DCAC converter version, DCDC converter version, serial number (SN code), and network port information.

图 3.8.4-6 菜单页面介绍

Figure3.8.4-6 Menu page introduction

登录 Log in

- 未登录时不可进入系统页面更改工作模式和设置参数，且登录后一个小时会自动退出登录，需重新登录。

OLP EC-PV650_P500_E1205-AO01 户外集装箱储能系统用户手册	文件编号: OLPSID-MU-25061601 Document number: OLPSID-MU-25061601	版本:V1.1 Version:V1.1	Page 59 of 106
©欧力普能源与自动化技术有限公司 2025 保留所有权利 © Olipower Energy & Automation Technologies 2025 All rights reserved.	地址: 深圳市光明区凤凰街道塘尾社区光明大道 380 号尚智科技园 2 栋 A 座 10 楼 Address: 10th Floor, Block A, Building 2, Shangzhi Science and Technology Park, No. 380 Guangming Avenue, Tangwei Community, Fenghuang Street, Guangming District, Shenzhen, China.		Tel: +86 (755) 2650 8686 Website: www.olipower.cn

When not logged in, access to the system page to change work modes and settings is not available, and the system will automatically log out one hour after logging in; users will need to log in again.

- 在“账户”中选择需要登录的账户，并输入密码后点击“登录”，可登录账户，登录成功后将回到主页。
To log in, select the required account in the "Account" section, enter the password, and click "Login". After a successful login, you will be redirected to the homepage.
- 账户为“用户”的初始密码为 123456。该用户模式下可修改工作模式和设置基础参数，可查看但不可设置高级设置参数。

The default password for the "User" account is 123456. In this user mode, you can modify work modes and set basic parameters, but you can only view and not set advanced parameters.

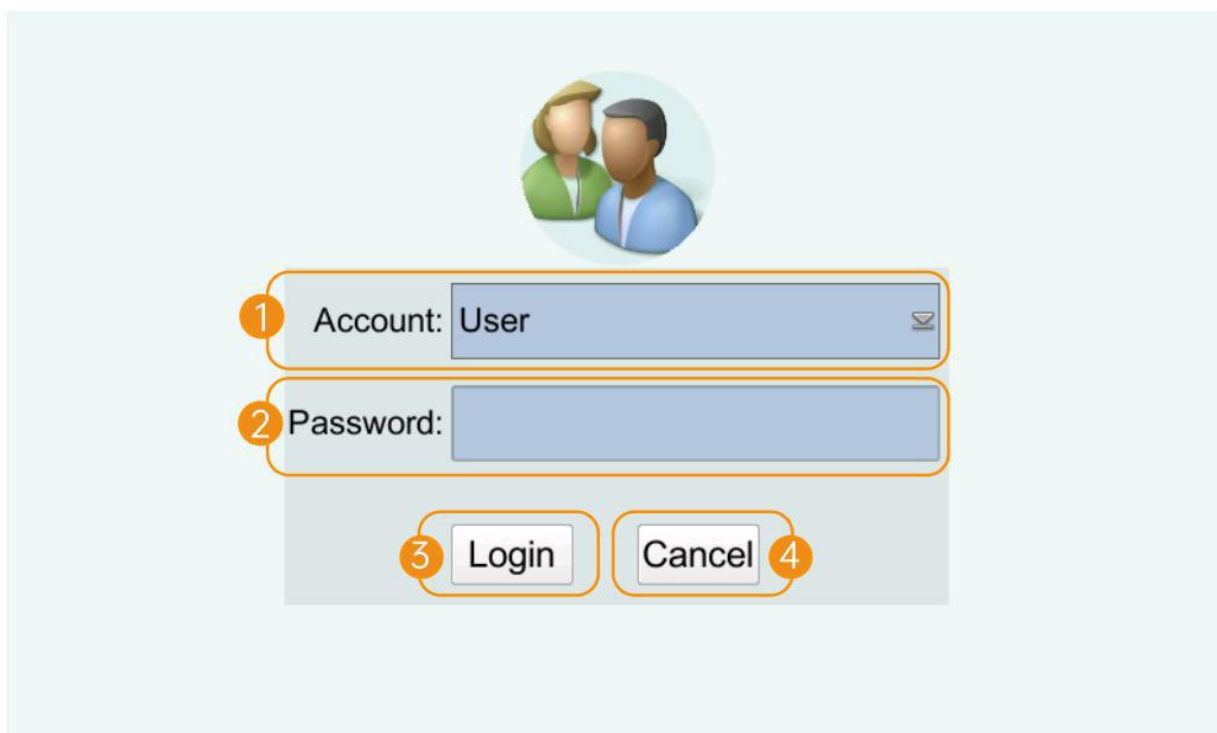

Login Interface Introduction

1. Account: Account login selection, including three account options: User, Maintenance, and Super Permission.

2. Password: Different accounts have different passwords, which can be changed in the advanced settings.

3. Login: Clicking login will proceed based on the selected account and entered password. Successful login will redirect to the homepage.

4. Cancel: Clicking cancel will return to the menu page.

图 3.8.4-7 登录界面介绍

Figure3.8.4-7 Login Interface Introduction

OLP EC-PV650_P500_E1205-AO01 户外集装箱储能系统用户手册	文件编号: OLPSID-MU-25061601 Document number: OLPSID-MU-25061601	版本:V1.1 Version:V1.1	Page 60 of 106
©欧力普能源与自动化技术有限公司 2025 保留所有权利 © Olipower Energy & Automation Technologies 2025 All rights reserved.	地址: 深圳市光明区凤凰街道塘尾社区光明大道 380 号尚智科技园 2 栋 A 座 10 楼 Address: 10th Floor, Block A, Building 2, Shangzhi Science and Technology Park, No. 380 Guangming Avenue, Tangwei Community, Fenghuang Street, Guangming District, Shenzhen, China.		Tel: +86 (755) 2650 8686 Website: www.olipower.cn

➤ **系统 System**

- 未登录时不可进入系统。系统中可查看各工作模式的模式介绍，切换工作模式，查看 / 设置基础设置和高级设置。

When not logged in, access to the system is restricted. Within the system, you can view introductions to various work modes, switch work modes, and view/set basic and advanced setting.

- 基础设置主要包括 DC/AC 参数、DC/DC 参数、电池设置参数，时间段设置。
Basic Settings includes DC/AC parameter, DC/DC parameters, Battery setting parameters, Time period.
- 高级设置主要包括功能设置、系统设置、外设、DC/AC 调式、DC/DC 调式、端口报文六个部分。
Advanced Settings consists of Function settings, System settings, Peripherals, DC/AC debug, DC/DC debug, Port message.



图 3.8.4-8 系统逻辑图

Figure3.8.4-8 System logic diagram

- 在系统界面中，当前应用并生效的工作模式的按钮的颜色为天蓝色，未生效的工作模式的按钮为淡蓝色，如图 3.8.6-9 所示，手动模式为当前正在生效的工作模式。

In the system interface, the button for the currently active and effective work mode is colored sky blue, while the buttons for the inactive work modes are light blue. As shown in Figure 3.8.6-9, Manual Mode is the work mode currently in effect.

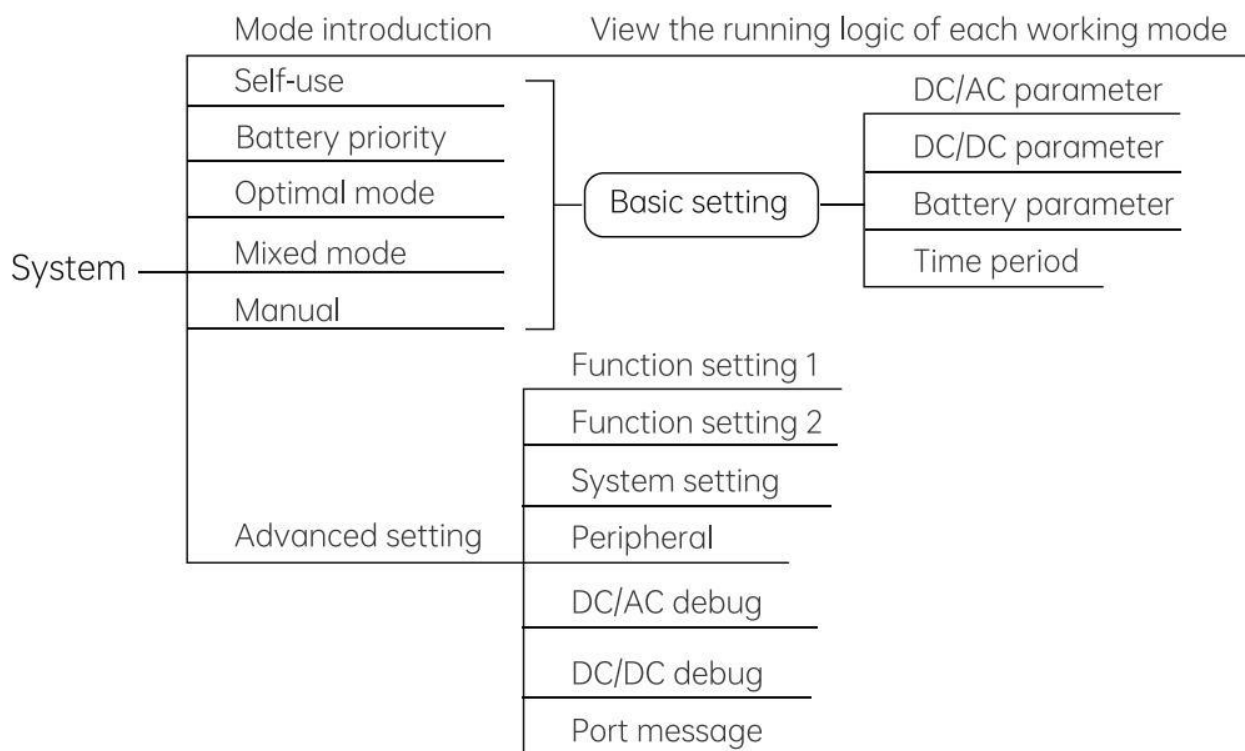
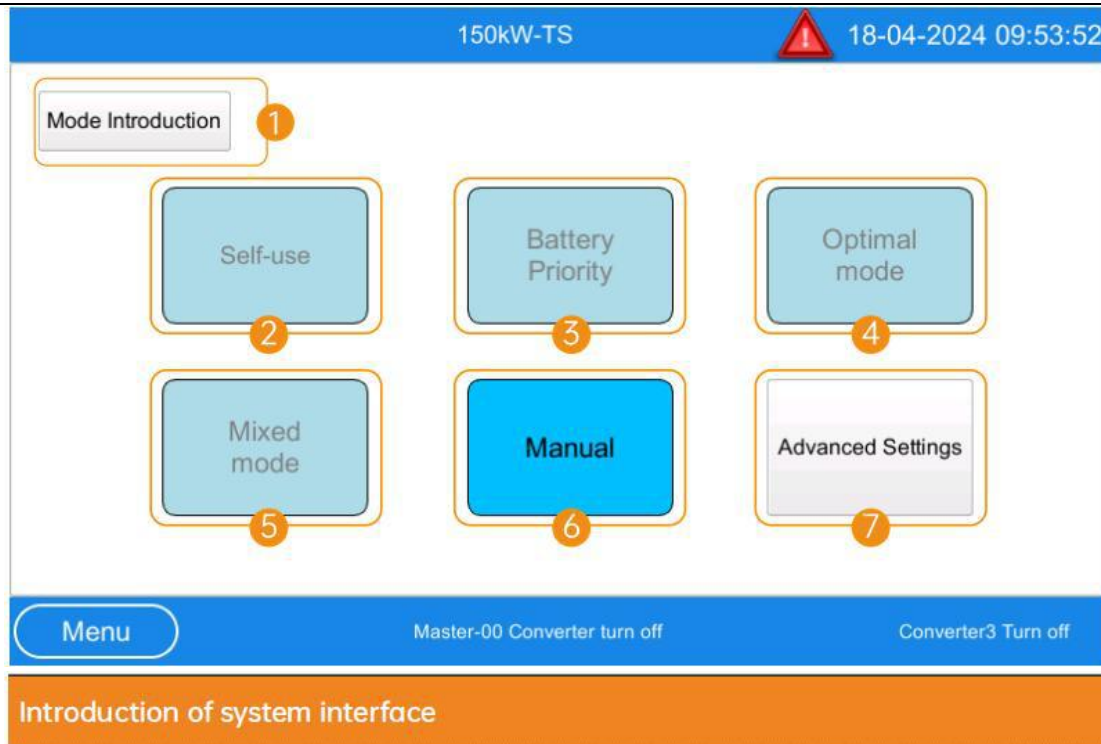

1. Mode introduction: Click to enter the Mode Introduction page to view the operational logic of each work mode.

2. Self-use: Click to enter the basic settings interface for the Self-use mode, where you can switch the current work mode to Self-use and set related basic parameters.

3. Battery priority: Click to enter the basic settings interface for Battery Priority mode, where you can switch the current work mode to Battery Priority and set related basic parameters.

4. Optimal mode: Click to enter the basic settings interface for Optimal Mode, where you can switch the current work mode to Optimal Mode and set related basic parameters.

5. Mixed mode: Click to enter the basic settings interface for Mixed mode, where you can switch the current work mode to Mixed mode and set related basic parameters.

6. Manual: Click to enter the basic settings interface for Manual Mode, where you can switch the current work mode to Manual and set related basic parameters.

7. Advanced settings: Click to enter the Advanced Settings interface.

图 3.8.4-9 系统界面介绍

Figure3.8.4-9 Introduction of system interface

OLP EC-PV650_P500_E1205-AO01 户外集装箱储能系统用户手册	文件编号: OLPSID-MU-25061601 Document number: OLPSID-MU-25061601	版本:V1.1 Version:V1.1	Page 62 of 106
---	---	-------------------------	----------------

1) 模式介绍 Mode Introduction

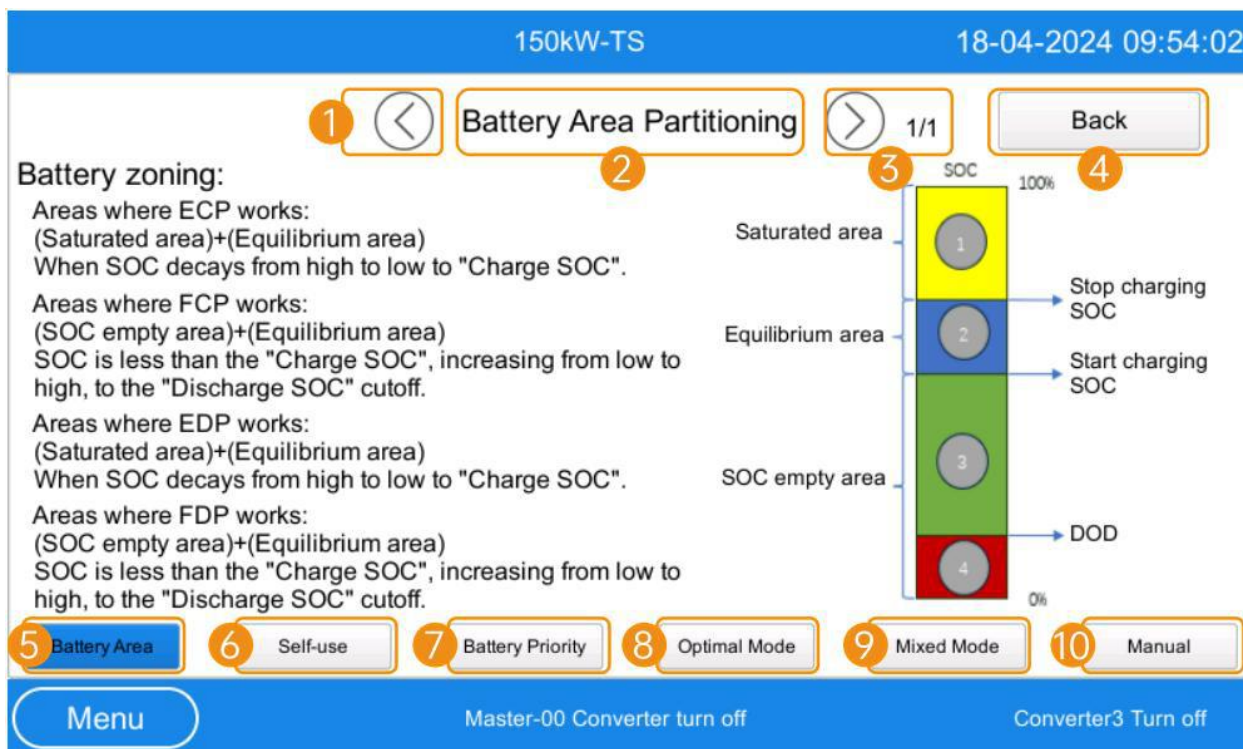

Mode introduction interface introduction

1. Previous page.
2. The currently selected introduction module.
3. The next page.
4. Return to the system page.
5. Click to view the introduction of battery area division.
6. Click to view the operation logic of the self-use mode.
7. Click to view the operation logic of battery priority mode.
8. Click to view the operation logic of the optimal mode.
9. Click to view the operation logic of the mixed mode.
10. See the manual mode logic.

图 3.8.4-10 模式介绍界面介绍

Figure3.8.4-10 Mode introduction interface introduction

<p>OLP EC-PV650_P500_E1205-AO01 户外集装箱储能系统用户手册</p>	<p>文件编号: OLPSID-MU-25061601 Document number: OLPSID-MU-25061601</p>	<p>版本:V1.1 Version:V1.1</p>	<p>Page 63 of 106</p>
<p>©欧力普能源与自动化技术有限公司 2025 保留所有权利 © Olipower Energy & Automation Technologies 2025 All rights reserved.</p>	<p>地址: 深圳市光明区凤凰街道塘尾社区光明大道 380 号尚智科技园 2 栋 A 座 10 楼 Address: 10th Floor, Block A, Building 2, Shangzhi Science and Technology Park, No. 380 Guangming Avenue, Tangwei Community, Fenghuang Street, Guangming District, Shenzhen, China.</p>		<p>Tel: +86 (755) 2650 8686 Website: www.olipower.cn</p>

2) 基础设置 Basic setting

- 在基础设置界面中，可通过翻页按钮切换上一页或下一页，点击“模式生效”将生效当前选中的模式，并退出基础设置界面返回到系统界面。

In the basic Settings interface, you can switch the previous page or the next page through the page turning button, click "Mode Effect" to effect the currently selected mode, and exit the basic Settings interface to return to the system interface.

- 基础设置包括 DC/AC 参数、DC/DC 参数、电池设置参数、时间段设置四个页面，在基础设置界面中部分变灰且不可设置的参数为当前所选的工作模式下设置无效的参数。

The basic Settings include four pages: DC/AC parameters, DC/DC parameters, battery Settings parameters and time period Settings. The parameters that are partially grayed out and cannot be set in the basic Settings interface are invalid parameters set in the currently selected working mode.

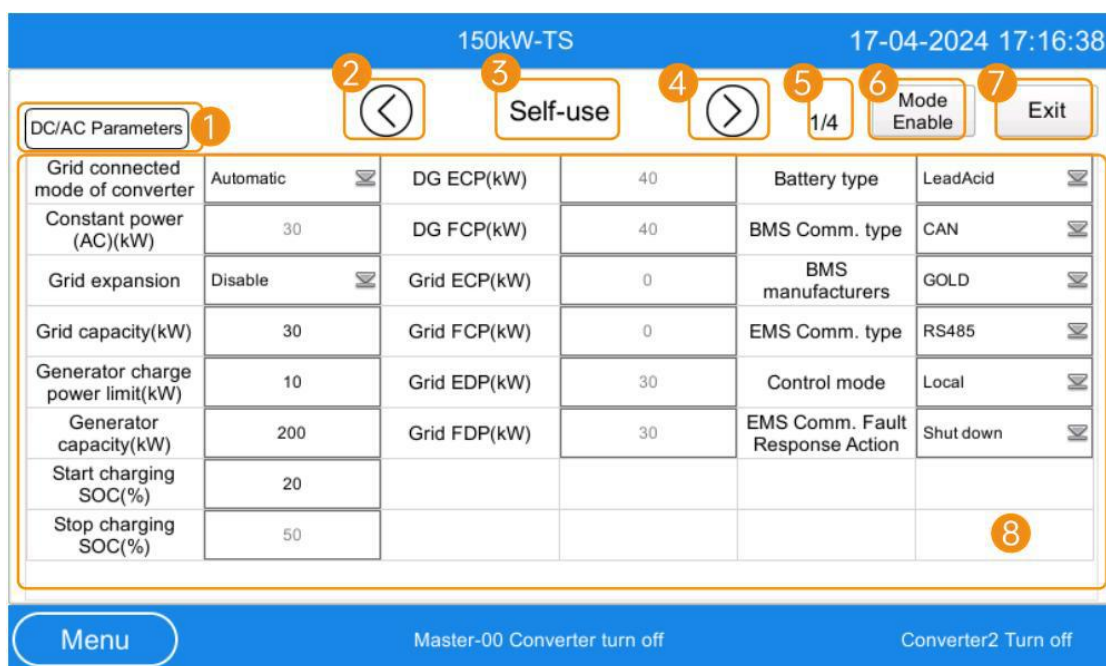

Introduction to the basic settings interface

- The title name of the page you are currently on.
- The previous page.
- The name of the currently selected working mode.
- The next page.
- The current page number and the total page number.
- Enable mode: Click to apply and effect the currently selected working mode.
- Exit: return to the system interface.
- Display the settings of the current page in this table.

图 3.8.4-11 基础设置界面介绍

OLP EC-PV650_P500_E1205-AO01 户外集装箱储能系统用户手册	文件编号: OLPSID-MU-25061601 Document number: OLPSID-MU-25061601	版本:V1.1 Version:V1.1	Page 64 of 106
---	---	-------------------------	----------------

Figure3.8.4-11 Introduction to the basic settings interface

3) 高级设置 Advanced setting

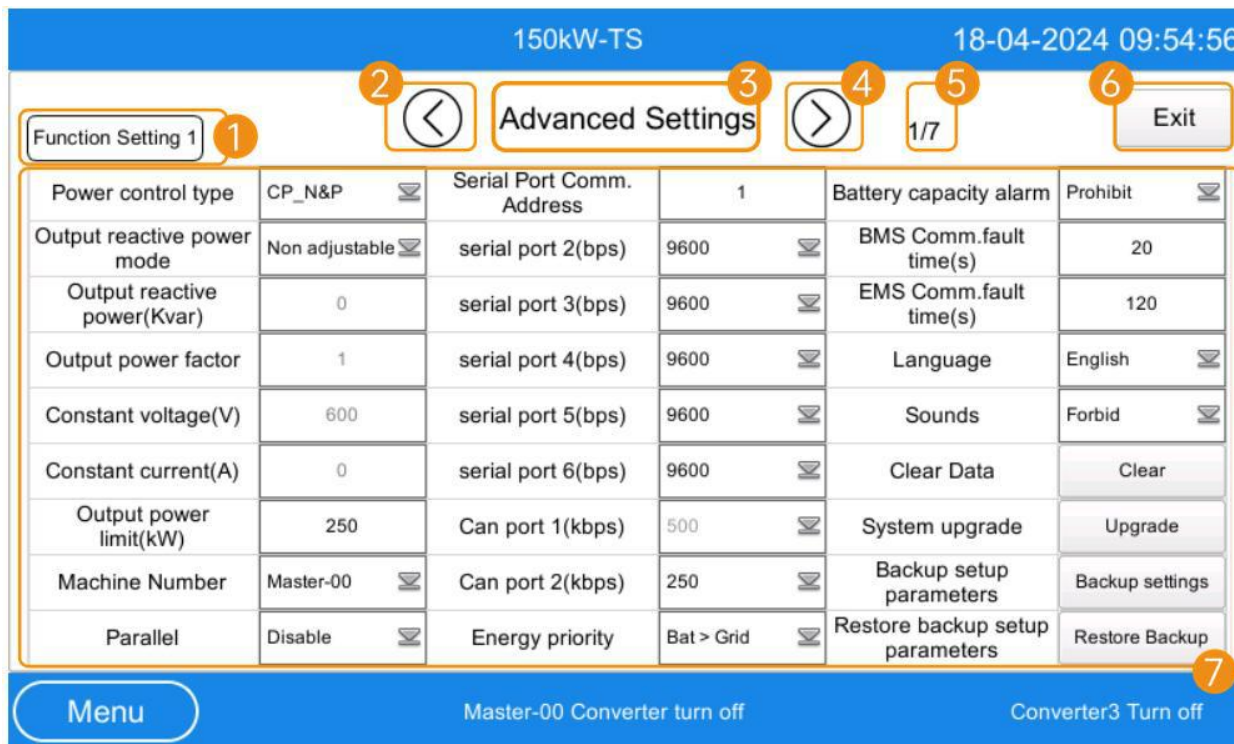

Introduction to the advanced settings interface

1. The title name of the page you are currently on.
2. The previous page.
3. The name of the interface you are currently on.
4. The next page.
5. The current page number and the total page number.
6. Exit: return to the system interface.
7. This table displays the Settings for the current page.

图 3.8.4-12 高级设置界面介绍

Figure3.8.4-12 Introduction to the advanced settings interface

实时数据 Real-time data

- 实时数据分为五个部分，分别为设备数据、设备状态、设备告警、电池数据、BMS 告警，这五部分的界面所显示的都是机器实时状态数据。

Real-time data is divided into five sections: Device Data, Device Status, Device Alarms, Battery Data, and BMS Alarms. Each of these sections displays real-time status data of the machine.



图 3.8.4-13 实时数据逻辑图
Figure3.8.4-13 Real-time data logic diagram

1) 设备数据 Device data

- 此界面显示的是机器运行时混合逆变器、PV、电网以及负载的实时数据，点击右侧的四个按钮即会显示混合逆变器设备各个功能单元的详细数据。点击交流器按钮后界面如图所示。

This interface displays real-time data of the machine's operation, including the inverter, PV (photovoltaics), the grid, and load. By clicking the four buttons on the right, detailed data for each functional unit of the MPS device is shown. After clicking the inverter button, the interface appears as shown in the diagram.

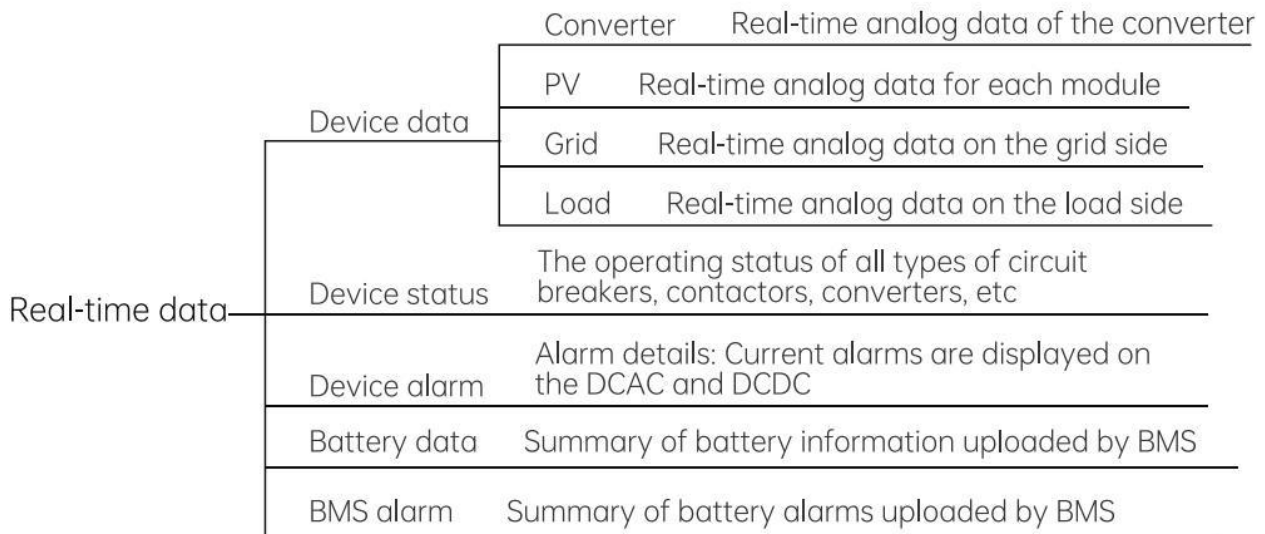
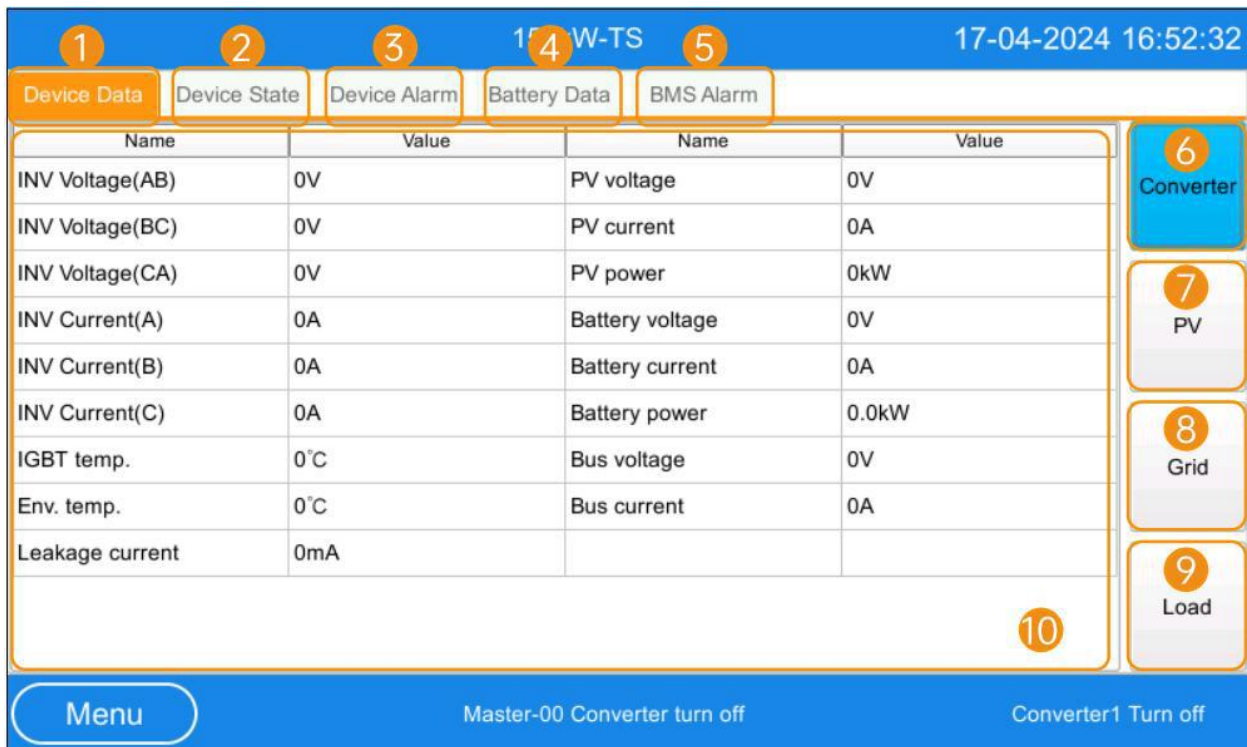

Introduction to the real-time data Interface

1. Device Data: View detailed real-time analog data for the inverter, PV (photovoltaics), grid, and load.
2. Device Status: View the operational status of various devices such as circuit breakers, contactors, and inverters.
3. Device Alarms: View current DCAC and DCDC alarms.
4. Battery Data: View a summary of battery data uploaded by the BMS (Battery Management System).
5. BMS Alarms: View BMS alarms uploaded by the BMS.
6. Inverter Button: Click to view analog data related to the inverter.
7. PV Button: Click to view analog data related to PV.
8. Grid Button: Click to view analog data related to the grid.
9. Load Button: Click to view analog data related to the load.
10. Real-Time Analog Data Display: This data is displayed in the table on this interface.

图 3.8.4-14 实时数据界面介绍

Figure3.8.4-14 Introduction to the real-time data Interface

- 点击 PV 按钮后，界面会跳转至 PV 数据界面，界面中的数据列表下有 12 个按钮代表的是模块数，不在线的模块数会变暗。界面如图 3.8.6-15 所示：
After clicking the PV button, the interface will switch to the PV data interface. The data list on this interface includes 12 buttons representing the number of modules. Modules that are not online will appear dimmed. The interface is shown as in Figure 3.8.6-15.



图 3.8.4-15 PV 数据
Figure3.8.4-15 PV data

- 点击电网按钮后界面如图 3.8.6-16 所示：
After clicking the grid button, the interface appears as shown in Figure 3.8.6-16.

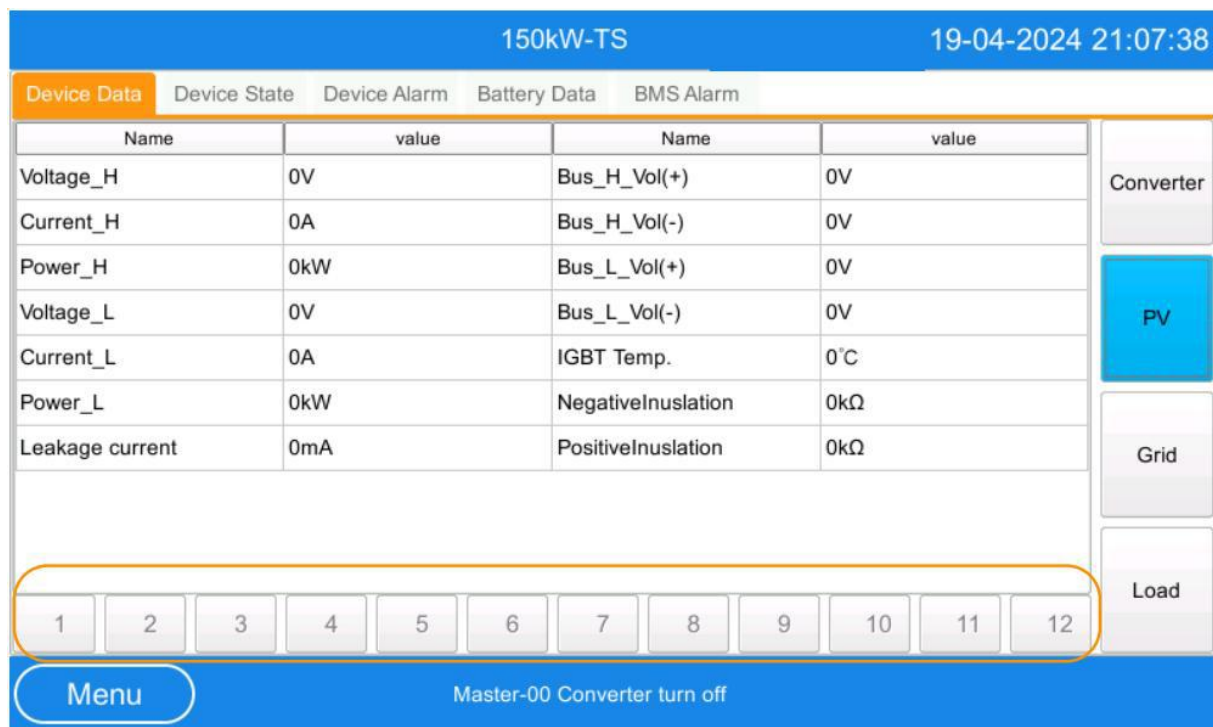

图 3.8.4-16 电网数据
Figure3.8.4-16 Grid data

- 点击负载按钮后界面如图 3.8.6-17 所示：
After clicking the load button, the interface appears as shown in Figure 3.8.6-17.

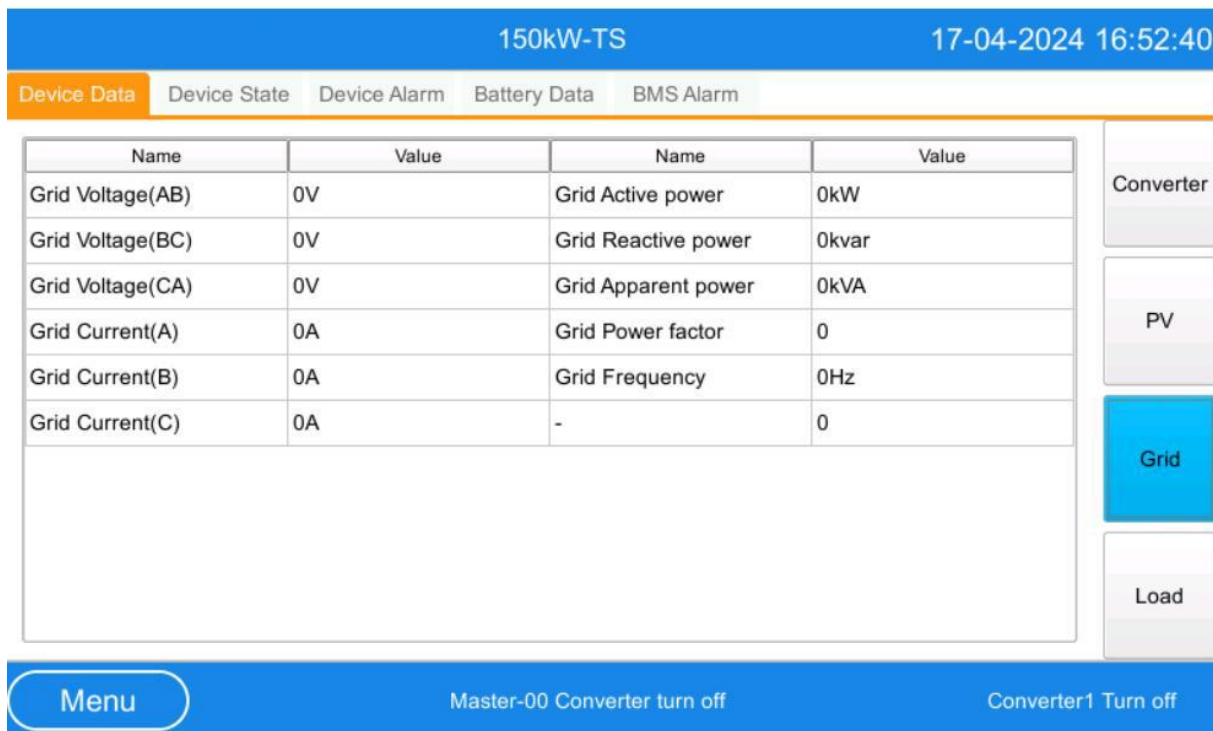

图 3.8.4-17 负载数据
Figure3.8.4-17 Load data

2) 设备状态 Device status

- 此界面主要是显示混合逆变器的各类断路器以及接触器，混合逆变器等的运行状态，其作用是可以更加方便直观的查看了解混合逆变器的运行状态。

This interface primarily displays the operational status of various components within the MPS, such as circuit breakers, contactors, and inverters. Its purpose is to provide a more convenient and intuitive way to understand the operational status of the MPS.

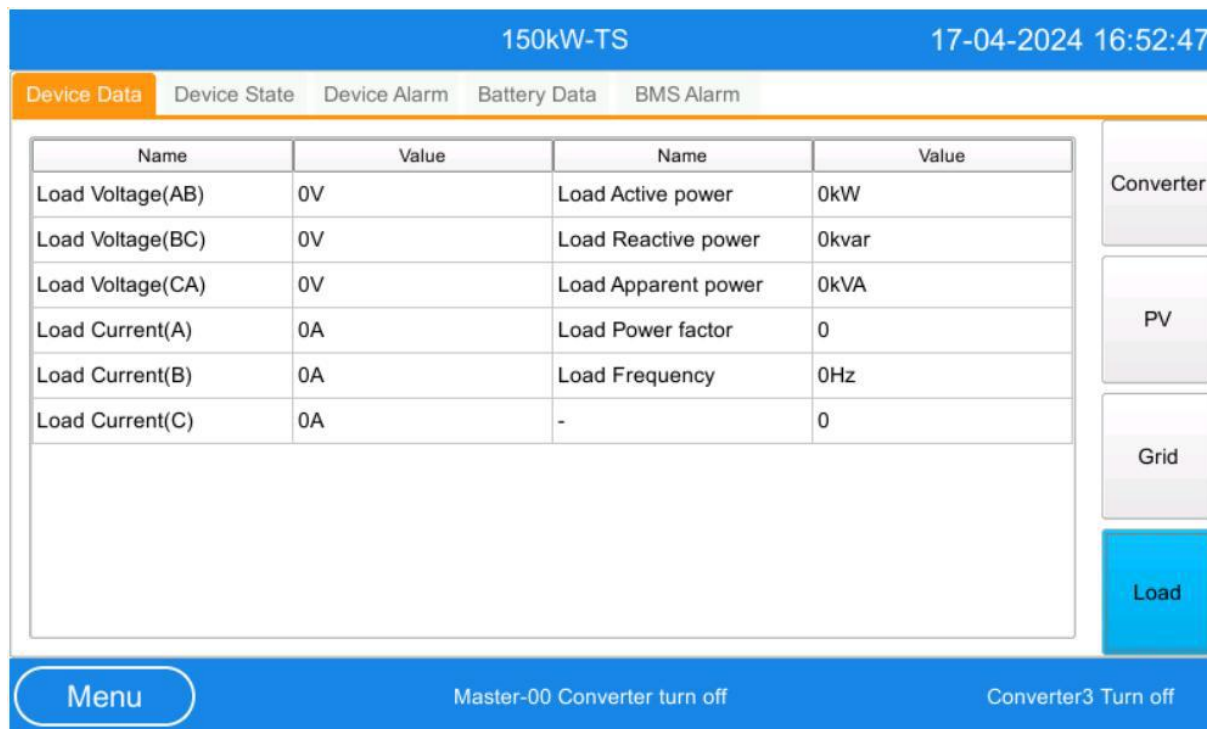
- 此界面数据有三列，每个数据都有其对应的状态，其中前两列数据对应的是 DCAC 模块的实时状态，第三列数据对应的是 DCDC 模块的状态。

The data on this interface is organized into three columns, each entry corresponding to a specific status. The first two columns represent the real-time status of the DCAC module, and the third column represents the status of the DCDC module.

- 数据列表下面有 12 个按钮代表的是模块数，不在线的模块数按钮会变暗，点击模块号会在显示模块状态更新对应模块的实时状态。

Below the data list, there are 12 buttons representing the number of modules. Buttons for modules that are not online will appear dimmed. Clicking on a module number will update and display the real-time status for that specific module.

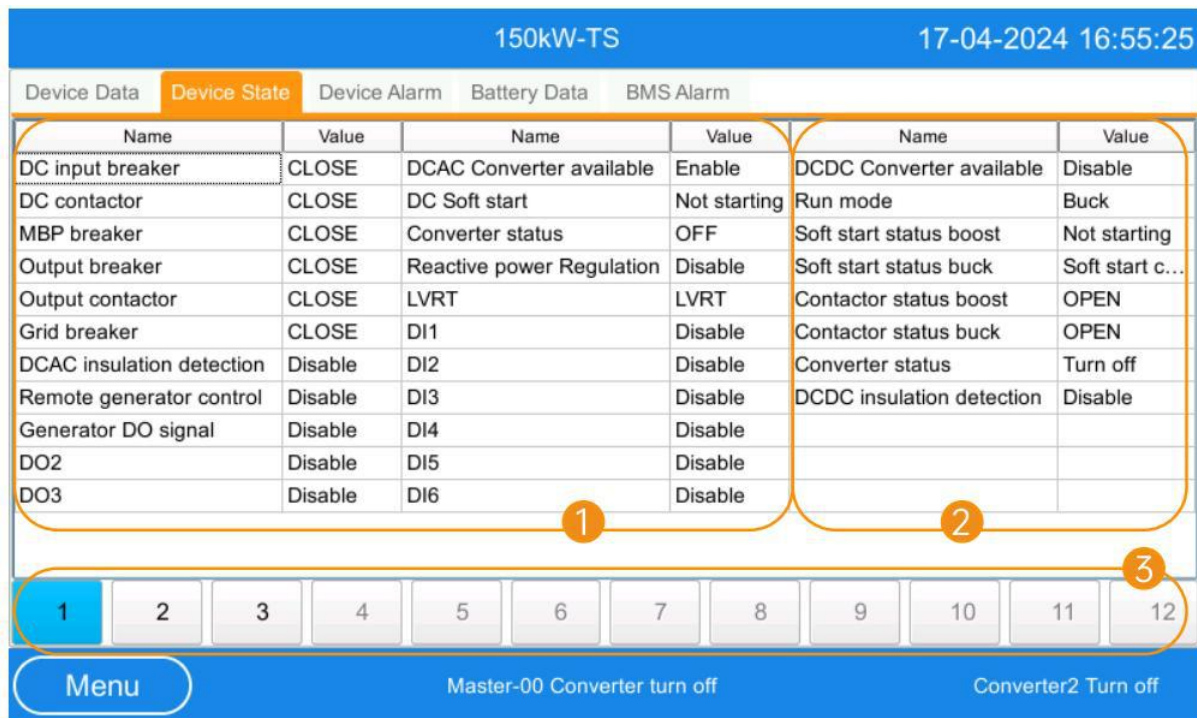

Device Status interface introduction

1. Display DCAC Status: Shows the status of the DCAC module.
2. Display DCDC Status: Shows the status of the DCDC module.
3. Select Module Number: Selecting a module number will update the corresponding module's PV status in section 2.

图 3.8.4-18 设备状态界面介绍
Figure3.8.4-18 Device status interface introduction

3) 设备告警 Device alarm

- 该界面用于显示机器在运行过程中出现的故障和告警，其中包括 DCAC 和 DCDC 的告警描述。
This interface is designed to display faults and alarms that occur during the operation of the machine, including descriptions of alarms related to DCAC and DCDC components.
- 用户可以查看告警信息的总页数以及当前页码。点击页码框可选择特定页数，也可通过点击“<”和“>”按钮来上下翻页，而“|<”和“>|”则分别代表首页和尾页。当机器运行出现故障时，用户可通过查看此界面了解故障原因，从而方便进行故障处理。

Users can view the total number of alarm pages as well as the current page number. By clicking on the page number box, users can select a specific page, or they can navigate through the pages using the "<" and ">" buttons for previous and next pages, respectively. The "|<" and ">|" symbols represent the first and last pages. When faults occur during machine operation, this interface allows users to understand the causes of these faults, facilitating effective troubleshooting.

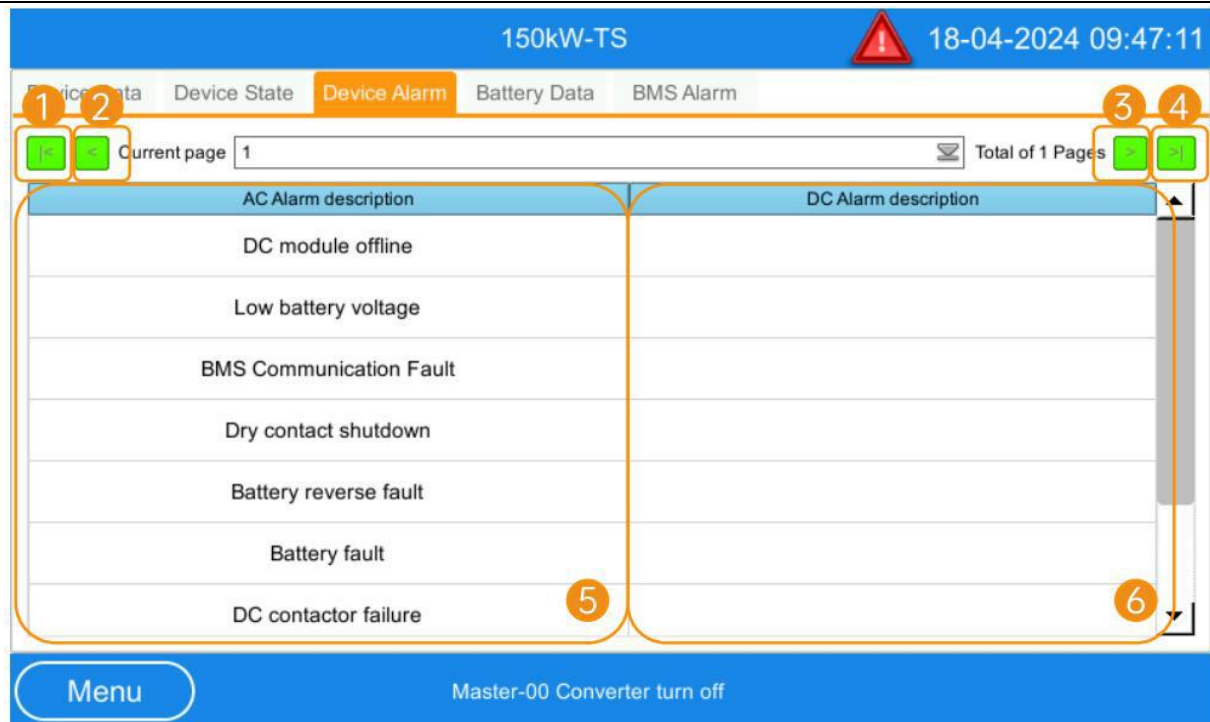

Device alarm interface introduction

1. |<: Clicking this button on the alarm description page will jump to the first page.
2. <: Previous page.
3. >: Next page.
4. >|: Clicking this button on the alarm description page will jump to the last page.
5. DCAC alarm description: Displays the current DCAC alarm that has been triggered.
6. DCDC alarm description: Displays the current DCDC alarm that has been triggered.

图 3.8.4-19 设备告警界面介绍

Figure3.8.4-19 Device alarm interface introduction

4) 电池数据（锂电池） Battery data (Lithium Battery)

- 此界面显示由 BMS 上传的电池数据。

This interface displays battery data uploaded by the Battery Management System (BMS).

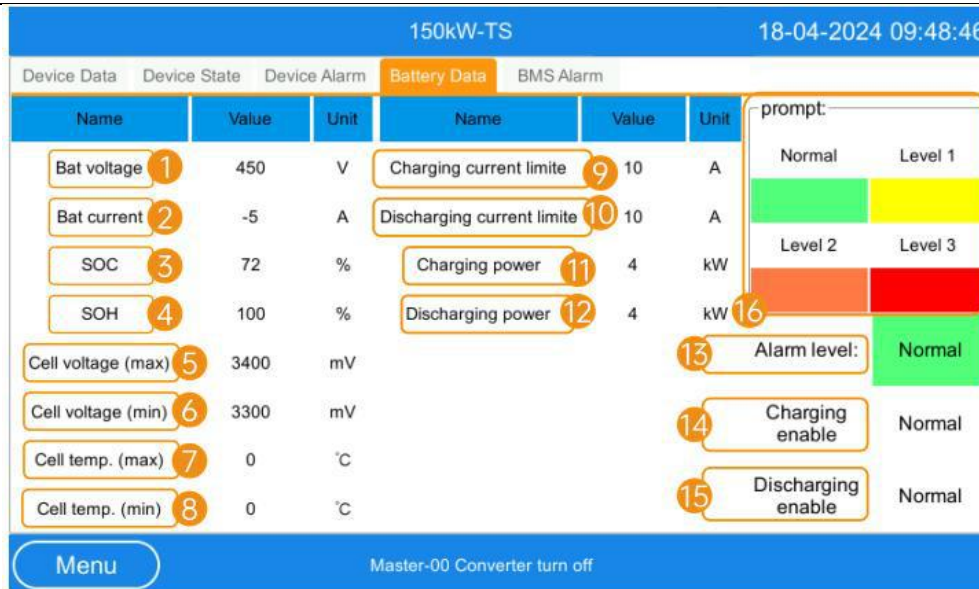

Lithium battery data interface introduction

1. Battery voltage: Total voltage of the battery pack uploaded by the BMS.
2. Battery current: Total current of the battery pack uploaded by the BMS.
3. SOC (state of charge): Percentage of the remaining charge in the battery pack uploaded by the BMS.
4. SOH (state of health): Percentage of the battery pack's usable capacity after full charge compared to its original capacity uploaded by the BMS.
5. Highest single cell voltage: Highest voltage of a single cell uploaded by the BMS.
6. Lowest single cell voltage: Lowest voltage of a single cell uploaded by the BMS.
7. Highest single cell temperature: Highest temperature of a single cell uploaded by the BMS.
8. Lowest Single Cell Temperature: Lowest temperature of a single cell uploaded by the BMS.
9. Charge current limit: Maximum charging current limit uploaded by the BMS.
10. Discharge current limit: Minimum discharge current limit uploaded by the BMS.
11. Charging power: Allowed charging power uploaded by the BMS.
12. Discharging power: Allowed discharging power uploaded by the BMS.
13. Alarm level: Alarm level uploaded by the BMS, where level one is yellow, level two is orange, and level three is red. By default, the inverter does not respond to level one and two alarms, and shuts down for level three alarms.
14. Charge enable: Battery status for charging uploaded by the BMS, where "enabled" means the battery can be charged and "disabled" means it cannot be charged.
15. Discharge enable: Battery status for discharging uploaded by the BMS, where "enabled" means the battery can discharge and "disabled" means it cannot discharge.
16. Alarm level color indication: Color indication for the current alarm level.

图 3.8.4-20 锂电池数据界面介绍

Figure3.8.4-20 Lithium battery data interface introduction

5) 电池数据（铅酸电池） Battery data (lead-acid battery)

- 此界面为铅酸电池数据界面。This interface is for lead-acid battery data.

150kW-TS		17-04-2024 16:56:26	
Device Data		Device State	
Device Alarm		Battery Data	
BMS Alarm			
Name	Value	Name	Value
Float voltage ①	572V	⑨ Battery status	Not running
Uniform charge voltage ②	592.2V	⑩ Battery power	0kW
Electric current ③	0A	⑪ DC/DC Rated charging power	150kW
Voltage ④	0V	⑫ DC/AC Rated discharging p...	150kW
Grid ON EOD ⑤	504V	⑬ SOC	50%
Grid OFF EOD ⑥	453.6V	-	-
Charging current limit ⑦	0.25C	-	-
Discharging current limit ⑧	0.5C	-	-

Menu Master-00 Converter turn off Converter3 Turn off

Lead-acid battery interface introduction

1. Float charge voltage: Calculated by multiplying the set float charge voltage of a single battery cell by the number of battery cells.
2. Uniform charge voltage: Calculated by multiplying the set equalization charge voltage of a single battery cell by the number of battery cells.
3. Current: Current on the DC side of the inverter.
4. Voltage: Voltage on the DC side of the inverter.
5. Grid ON EOD: Cut-off voltage for discharging when connected to the grid.
6. Grid OFF EOD: Cut-off voltage for discharging when not connected to the grid.
7. Charge current limit: The maximum allowable current on the battery side to prevent overcurrent during charging. (Upper limit of 0.25C)
8. Discharge current limit: The maximum allowable current on the battery side to prevent overcurrent during discharging. (Upper limit of 0.5C)
9. Battery status: Monitors the operational state of the battery.
10. Battery power: Current power of the battery during charging and discharging.
11. DC/DC rated charging power: Total rated power of the DC/DC module on the DC side.
12. DC/AC rated charging power: Rated power on the AC side for DC/AC, similar to the machine model.
13. SOC (state of charge): Calculated based on the total voltage of the battery, representing the percentage of remaining battery power.

图 3.8.4-21 铅酸电池数据界面介绍

Figure3.8.4-21 Lead-acid battery interface introduction

Olp EC-PV650_P500_E1205-AO01 户外集装箱储能系统用户手册	文件编号: OLPSID-MU-25061601 Document number: OLPSID-MU-25061601	版本:V1.1 Version:V1.1	Page 73 of 106
---	---	-------------------------	----------------

6) BMS 告警 BMS alarm

- 该界面用于显示 BMS 上传的故障和告警信息。

This interface is designed to display fault and alarm information uploaded by the Battery Management System (BMS).

- 用户可以查看告警信息的总页数以及当前页码。点击页码框可选择特定页数,也可通过点击“<”和“>”按钮来上下翻页,而“|<”和“>|”则分别代表首页和尾页。当 BMS 检测到告警或故障并上传时,用户可通过查看此界面了解故障原因,从而方便进行故障处理。

Users can view the total number of alarm pages as well as the current page number. By clicking the page number box, users can select a specific page, or they can navigate through the pages using the "<" and ">" buttons for moving backward and forward, respectively. The "|<" and ">|" symbols represent the first and last pages respectively. When the BMS detects and uploads an alarm or fault, users can view this interface to understand the cause of the fault, facilitating effective troubleshooting.

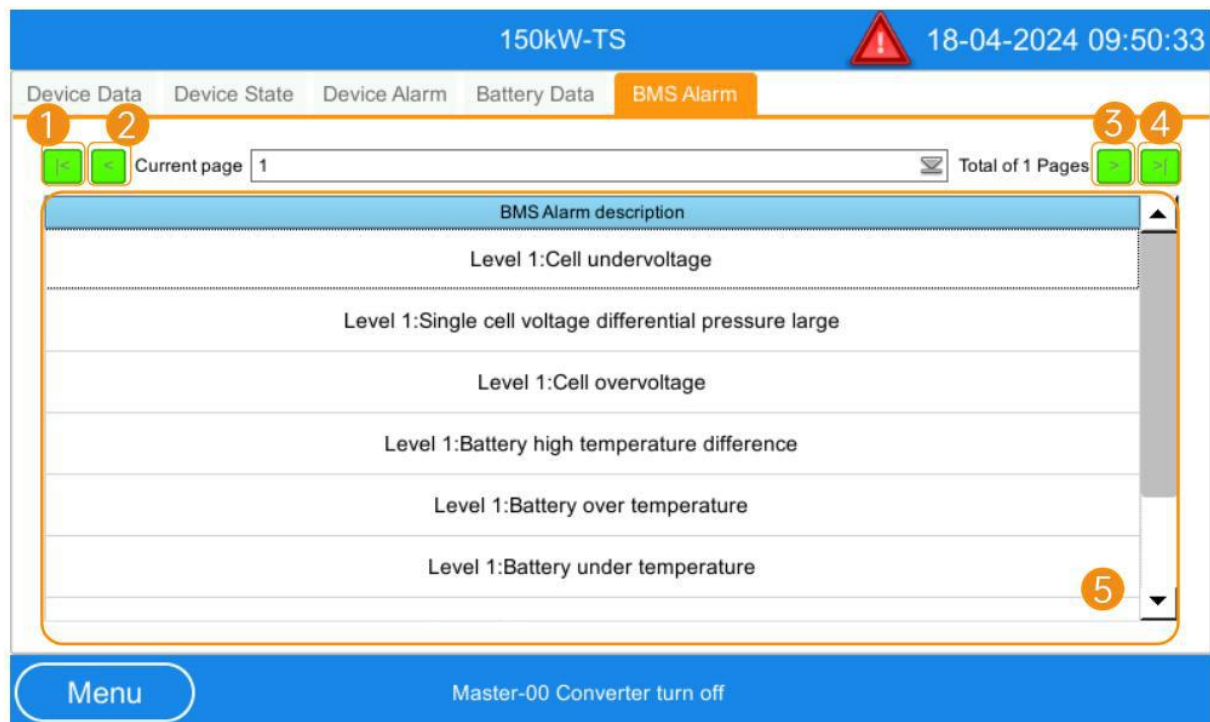

BMS alarm interface introduction

1. |<: Clicking this button on the alarm description page will jump to the first page.
2. <: Previous page.
3. >: Next page.
4. >|: Clicking this button on the alarm description page will jump to the last page.
5. BMS Alarm Description: Displays the current BMS alarm that has been triggered.

图 3.8.4-21 BMS 告警界面介绍

Figure3.8.4-21 BMS alarm interface introduction

OLP EC-PV650_P500_E1205-AO01 户外集装箱储能系统用户手册	文件编号: OLPSID-MU-25061601 Document number: OLPSID-MU-25061601	版本:V1.1 Version:V1.1	Page 74 of 106
---	---	-------------------------	----------------

记录 Record

- 这个部分包括四个功能部分：数据报表、导出数据、历史记录和操作日志。这些功能旨在统计设备的充放电电量，记录系统运行的历史记录和操作日志，以方便查询和追溯。

This section includes four functional areas: Data Reports, Export Data, Historical Records, and Operation Logs. These features are designed to track the charging and discharging amounts of the equipment, record the system's operational history and logs, facilitating easy querying and tracing.



图 3.8.4-22 记录逻辑图

Figure3.8.4-22 Record logic diagram

1) 数据报表 Data reports

- 记录了 PV、负载、电池和电网的充放电电量，包括日、月、年和总电量。右侧有时间查询按钮，可查询特定日期的电量数据。用户可通过点击“年 +”或“年 -”按钮设置年份，每次点击按钮年份将增加或减少 1，月份和日期也可通过类似方式设置，以便查看特定日期的报表。
- This section logs the charging and discharging data for PV (photovoltaics), load, battery, and the grid, including daily, monthly, yearly, and total electricity amounts. There is a time query button on the right side, which allows users to search for electricity data on specific dates. Users can set the year by clicking the "Year+" or "Year-" buttons, with each click increasing or decreasing the year by one. The month and day can also be adjusted in a similar manner to view reports for specific dates.

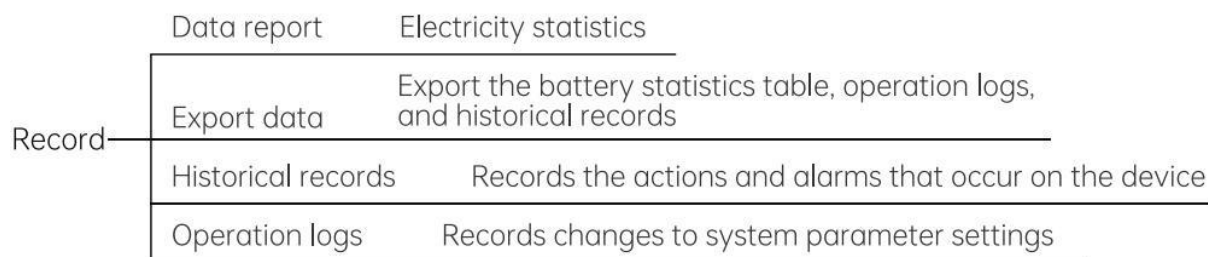
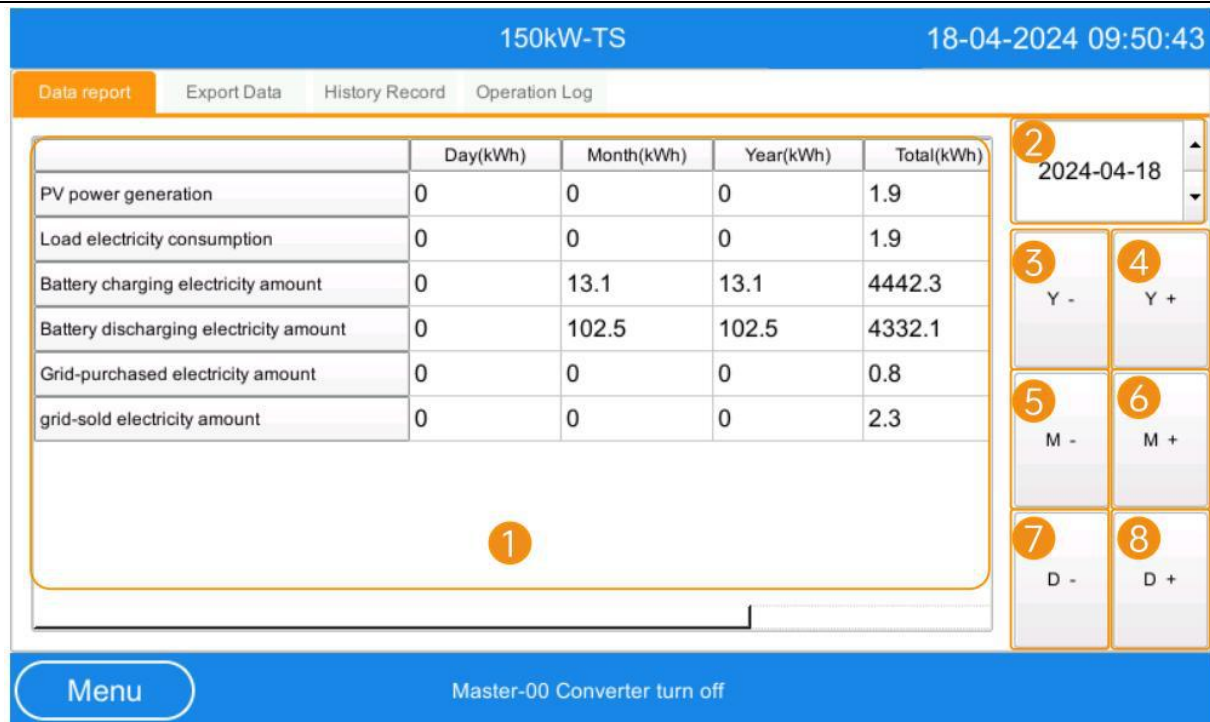

Data reports interface introduction

1. Data reports: Displays the recorded charging and discharging amounts for PV, load, battery, and the grid for the currently selected date in a table format.
2. Current data report date: Shows the date of the data report currently being viewed.
3. Year-: View the data from the previous year.
4. Year+: View the data from the next year.
5. Month-: View the data from the previous month.
6. Month+: View the data from the next month.

Data reports interface introduction

7. Day-: View the data from the previous day.
8. Day+: View the data from the following day.

图 3.8.4-23 数据报表界面介绍
Figure3.8.4-23 Data reports interface introduction

2) 导出数据 Export data

- 此界面是用于数据导出的，首先要求 U 盘的格式为 FAT32 格式，然后查看状态栏查看 U 盘是否已经插入，如果提示 U 盘已经插入的，即可选择要导出的数据类型点击导出数据，待数据导出完成时，点击退出 U 盘按钮就完成了数据导出操作。
- This interface is used for data export. Initially, it requires that the USB drive be formatted in

FAT32. Users should check the status bar to see if the USB drive is inserted. If the interface indicates that the USB drive is inserted, users can select the type of data they wish to export and click on the export data button. Once the data export is complete, clicking the 'eject USB drive' button will finalize the data export process.



Data export interface introduction

1. Export history to USB: The filename for history records exported to a USB drive is "Record.csv".

2. Export operation log to USB: The filename for operation logs exported to a USB drive is "Log.csv".

3. Export electricity statistics to USB: The filename for electricity statistics exported to a USB drive is "Report.csv".

4. USB status display: Here you can check the connection status of the USB drive.

5. History records export button: This button exports the history records to a USB drive. The file, "Record.csv", needs to be opened with Excel.

6. Operation log export button: Click here to export the operation log to a USB drive.

7. Electricity statistics export button: Click here to export the electricity statistics report to a USB drive.

8. Eject USB drive: This option safely removes the USB drive after the export operations are complete.

图 3.8.4-24 导出数据界面介绍
Figure3.8.4-24 Data export interface introduction

OLP EC-PV650_P500_E1205-AO01 户外集装箱储能系统用户手册	文件编号: OLPSID-MU-25061601 Document number: OLPSID-MU-25061601	版本:V1.1 Version:V1.1	Page 77 of 106
---	---	-------------------------	----------------

3) 历史记录 Historical Records

- 此界面是用于记录设备运行过程中产生的状态记录和故障记录的开始时间以及结束时间。
- This interface is designed to log the start and end times of status records and fault records that occur during the operation of the equipment.

150kW-TS		18-04-2024 09:50:59					
Data report		Export Data		History Record		Operation Log	
1	Level	2	Start time	3	End time	4 Describe	
1	2	2024-4-18 9:50:27	...	Battery high temperature difference			
2	2	2024-4-18 9:50:26	...	Single cell voltage differential pressure large			
3	2	2024-4-18 9:50:26	...	Total voltage undervoltage			
4	2	2024-4-18 9:50:26	...	Total voltage overvoltage			
5	2	2024-4-18 9:50:26	...	Battery under temperature			
6	2	2024-4-18 9:50:26	...	Battery over temperature			
7	2	2024-4-18 9:50:25	...	Cell overvoltage			
8	2	2024-4-18 9:50:25	...	Cell undervoltage			
9	2	2024-4-18 9:49:30	2024-4-18 9:49:52	Single SOC Too Low			
10	2	2024-4-18 9:49:29	2024-4-18 9:49:52	Discharge overcurrent			
11	2	2024-4-18 9:49:28	2024-4-18 9:49:52	Charge overcurrent			

Menu Master-00 Converter turn off

Historical records interface introduction

1. Level: 0 indicates an alarm event and will be highlighted in red; 1 indicates a status event.
2. Event start time
3. Event end time
4. Event description

图 3.8.4-25 历史记录界面介绍

Figure3.8.4-25 Historical records interface introduction

4) 操作日志 Operation Logs

- 此界面用于记录系统的一些重要参数的修改记录。
- This interface is used to record the modifications made to some of the system's important parameters.

150kW-TS		18-04-2024 09:53:22	
Data report		Export Data	
History Record		Operation Log	
1	ModificationTime	2	RecordEvent
1	2024-04-18 09:53:15		Control mode: Remote -> Local
2	2024-04-18 09:53:14		Control mode: Local -> Remote
3	2024-04-18 09:53:01		Grid active power percent: 50 -> 0
4	2024-04-18 09:52:48		Grid active power percent: 35 -> 50
5	2024-04-18 09:52:44		Grid active power percent: 20 -> 35
6	2024-04-18 09:52:41		Inv ON/Off-Grid: Off -> On
7	2024-04-18 09:52:39		Inv ON/Off-Grid: automatic -> Off
8	2024-04-18 09:52:12		BMS communication Type: EMS Dispatch -> CAN
9	2024-04-18 09:52:11		BMS communication Type: Non -> EMS Dispatch
10	2024-04-18 09:52:10		BMS communication Type: Ethernet -> Non
11	2024-04-18 09:52:08		BMS communication Type: RS485 -> Ethernet

Menu Master-00 Converter turn off Converter1 Turn off

Operation log interface introduction

1. Modification time: The time when the system settings were modified.
2. System settings operation record: A log of the operations performed on the system settings.

图 3.8.4-26 操作日志界面介绍
Figure3.8.4-26 Operation log interface introduction

开/关机 Turn on/off

- 在该界面可控制 DCAC 混合逆变器和 DCDC 变流器的开启和关闭。
- The opening and closing of DCAC converter and DCDC converter can be controlled by the interface.

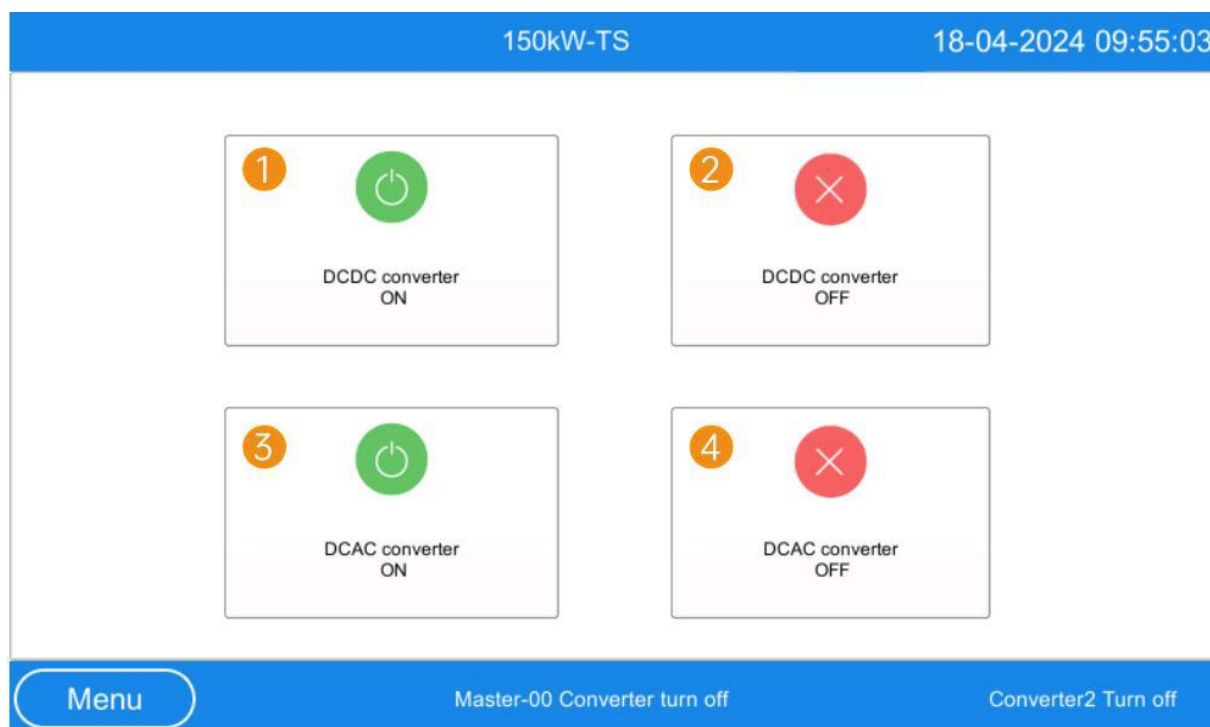

Turn on/off interface introduction

1. Click to open the DCDC converter.
2. Click to close the DCDC converter.
3. Click to open the DCAC converter.
4. Click to close the DCAC converter.

图 3.8.4-27 开关机界面介绍

Figure3.8.4-27 Turn on/off interface introduction

系统信息 System information

- 系统信息界面显示的是当前运行系统的监控版本、DCAC 混合逆变器版本、DCDC 变流器版本等版本信息以及网口信息。
- The system information interface displays the version information of the current running system, such as the monitoring version, the DCAC converter version, the DCDC converter version and the network port information.

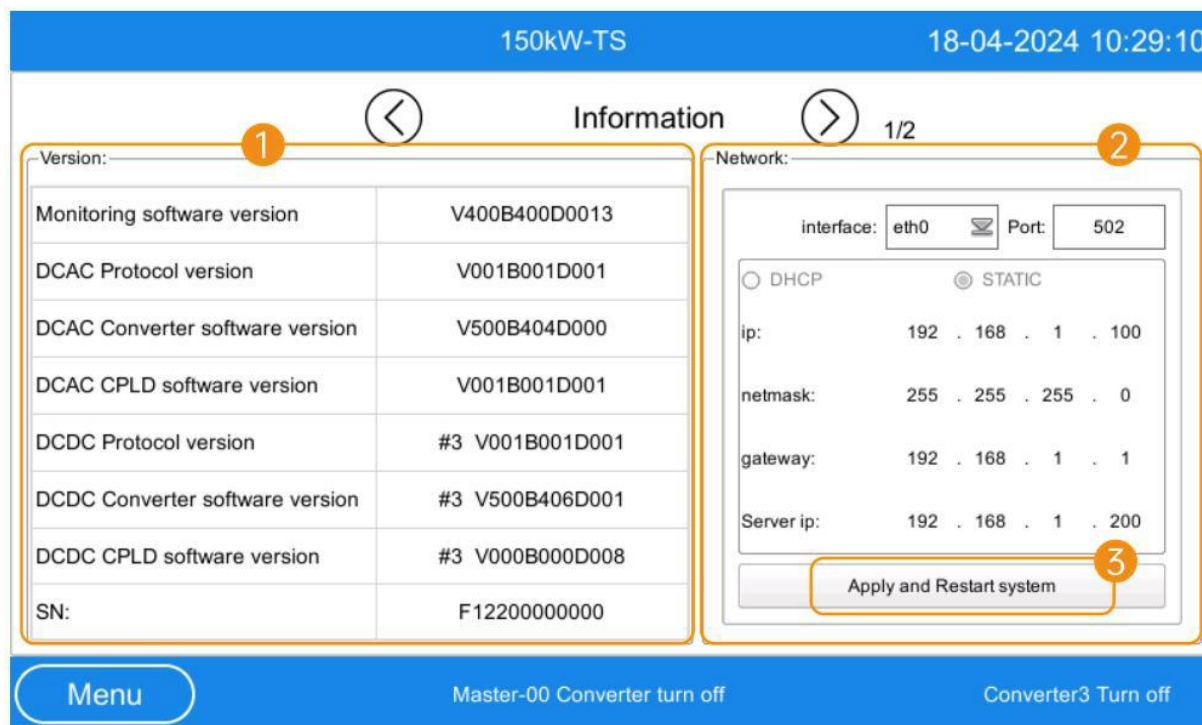

System information interface introduction

1. Display the current system version information.
2. Display the current monitored network port information.
3. The monitoring device will be restarted after clicking.

图 3.8.4-27 系统信息界面介绍

Figure3.8.4-27 System information interface introduction

3.8.5.热管理系统 Thermal Management System

空调主要由压缩机、风机、冷凝器、蒸发器、电加热、主控板以及其他配件构成。

Air conditioner is mainly made up of compressors, fans, condensers, evaporators, electric heating, main control boards, and other accessories.

空调用于调节储能系统内环境温度，确保电池组在合适温度范围内工作，以维持系统的最佳工作状态和提高系统使用寿命，其功能如下：

The air conditioner is used to regulate the ambient temperature within the energy storage system to ensure that the battery pack operates within the appropriate temperature range to maintain the optimal working condition of the system and to improve the service life of the system, and its functions are as follows:

监控电池仓内环境温度，根据环境温度和电池组内部温度自动调节温度输出。

Monitor the ambient temperature inside the battery compartment and automatically adjust the temperature output according to the ambient temperature and the internal temperature of the battery pack.

OLP EC-PV650_P500_E1205-AO01 户外集装箱储能系统用户手册	文件编号: OLPSID-MU-25061601 Document number: OLPSID-MU-25061601	版本:V1.1 Version:V1.1	Page 81 of 106
---	---	-------------------------	----------------

电池仓温度较高时，空调降低电池仓环境温度，防止热失控事故。

When the temperature of the battery compartment is high, the air conditioner reduces the ambient temperature of the battery compartment to prevent thermal runaway accidents.

电池仓温度较低时，空调可进行预热，提高环境温度，确保系统在低温环境下充放电性能与安全性，同时提高系统的使用效率。

When the temperature of the battery compartment is low, the air conditioner can preheat and raise the ambient temperature to ensure the system's charging and discharging performance and safety in a low-temperature environment, as well as to improve the system's utilization efficiency.

制冷模式 cooling mode

制冷时，压缩机将制冷剂压缩成液体，而此时将液体送入电池仓内，此时电池仓内热空气和蒸发器接触，液体制冷剂受热变气态，带走电池仓内热量，到冷凝器，在风机吹动及压力变化下，快速放热到电池仓外。

Refrigeration, the compressor will compress the refrigerant into liquid, and at this time the liquid will be sent to the battery compartment, at this time the hot air in the battery compartment and the evaporator contact, the liquid refrigerant is heated into a gaseous state, take away the heat in the battery compartment, to the condenser, in the fan blowing and the pressure change, the rapid exothermic to the outside of the battery compartment.

制热模式 heating mode

制热时，风机与电加热启动，将经过热风吹动至电池仓内，达到制热效果。

When heating, the fan and electric heating are activated to blow the passing hot air into the battery compartment to achieve the heating effect.

条目 Item	参数 Specification
额定功率 Rated Power	1.1kW
制冷量 cooling capacity	3kW
制热量 calorimetric	2kW
工作环境温度 Working environment temperature	-40°C~+55°C
电源 power supply	220±15%, 50/60Hz/12A
尺寸(W*D*H) Size (W*D*H)	500×250×1300mm
防护等级 protection class	IPX5
通讯方式 communication method	RS485
通讯协议 communication protocols	Modbus RTU

表 3.8.5-1 空调技术参数

OLP EC-PV650_P500_E1205-AO01 户外集装箱储能系统用户手册	文件编号: OLPSID-MU-25061601 Document number: OLPSID-MU-25061601	版本:V1.1 Version:V1.1	Page 82 of 106
---	---	-------------------------	----------------

Table 3.8.5-1 Air conditioner technical specification

3.8.6.消防系统 Fire Protection System

电池舱采用全淹没灭火方式，用 1 套全氟己酮灭火装置，灭火装置安装于电气舱内，灭火装置包括全氟己酮瓶组、电磁阀等零部件，管网布置在储能舱内部。

The battery compartment adopts a fully submerged fire extinguishing method, using one set of perfluorohexane fire extinguishing device installed in the electrical compartment. The fire extinguishing device includes perfluorohexane bottle group, solenoid valve and other components, and the pipeline network is arranged inside the energy storage compartment.

电池舱舱级探测由防爆点型感温探测器以及防爆点型感烟探测器探测设备组成。当火灾探测器或可燃气体探测器探测到火情危险则触发报警信号，报警信号传输到火灾报警控制器，由火灾报警控制器联动声光报警装置等进行报警。

The battery compartment level detection consists of explosion-proof point type temperature detectors, and explosion-proof point type smoke detectors. When a fire detector or combustible gas detector detects the danger of a fire, it triggers an alarm signal, which is transmitted to the fire alarm controller. The fire alarm controller then links the sound and light alarm devices to sound the alarm.

电池舱居中布置 1 路气体管道，设置两只气体喷头，对电池舱进行防护。当烟感+温感报警时，同时将火警信号传输到火灾报警控制器，火灾报警控制器开启灭火瓶头阀，灭火药剂经管路释放到电池舱内，达到舱级防护目的。

One gas pipeline is arranged in the center of the battery compartment, and two gas nozzles are installed to protect the battery compartment. When the smoke and temperature sensors sound an alarm, the fire alarm signal is also transmitted to the fire alarm controller. The fire alarm controller opens the fire extinguishing bottle valve, and the extinguishing agent is released into the battery compartment through the pipeline, achieving the purpose of compartment level protection.

水喷淋系统：电池舱内设置有水喷淋管网，预留消防给水接口。在电池舱设有 1 路水喷淋管道，设置 6 只水淋喷头。消防水喷淋管路是整套集装箱式储能消防系统的最后一道防线，当火势无法控制时，人为从外部接入当地消防栓或其他消防给水系统向箱体内灌水实现最终消防目的。

Water spray system: A water spray pipe network is installed inside the battery compartment, with reserved fire water supply interfaces. There are 1 water spray pipes and 6 water spray nozzles installed in the battery compartment. The fire water sprinkler pipeline is the last line of defense for the entire containerized energy storage fire protection system. When the fire cannot be controlled, it is artificially connected to the local fire hydrant or other fire water supply system from the outside to inject water into the box to achieve the ultimate fire protection purpose.

储能通风系统：为储能单元而专门设计的通风系统，储能通风系统分排风及进风两个独立单元，排风采用机械式，进风采用自然进风。当电池舱内可燃气体浓度达到预设报警值时，消防设备自动开启储能通风系统进行排风，当气体灭火系统启动实施舱级灭火时，储能通风系统自动关闭。

Energy storage ventilation system: a ventilation system specially designed for energy storage units. The energy storage ventilation system is divided into two independent units: exhaust and intake, with mechanical exhaust and natural intake. When the concentration of combustible gases in the battery compartment reaches the preset alarm value, the fire-fighting equipment automatically starts the energy storage ventilation system for exhaust. When the gas fire extinguishing system is

OLP EC-PV650_P500_E1205-AO01 户外集装箱储能系统用户手册	文件编号：OLPSID-MU-25061601 Document number: OLPSID-MU-25061601	版本:V1.1 Version:V1.1	Page 83 of 106
---	--	-------------------------	----------------

activated to implement compartment level fire extinguishing, the energy storage ventilation system automatically shuts down.



图 3.8.6-1 消防系统拓扑图

Figure 3.8.6-1 Topology diagram of fire protection system

3.8.7.水浸系统 Water immersion system

水浸系统是由水浸变送器和水浸传感器组成。隔离式水浸探测器根据探测电极浸水后阻抗发生变化，通过信号处理电路对水浸输入信号进行信号放大、整形、比较，输出干接点或高低电平变化信号，指示探测器所在位置是否有水；结构采用一体化全密封塑料外壳设计，保证了产品的高可靠性；实现电源输入、输出全隔离，保证了产品可靠性高及抗干扰性强。该水浸探测器采用继电器输出报警信号方式，当水浸探测器探测到有水淹没，输出报警信号给 EMS，EMS 立刻控制整个储能系统停止工作。

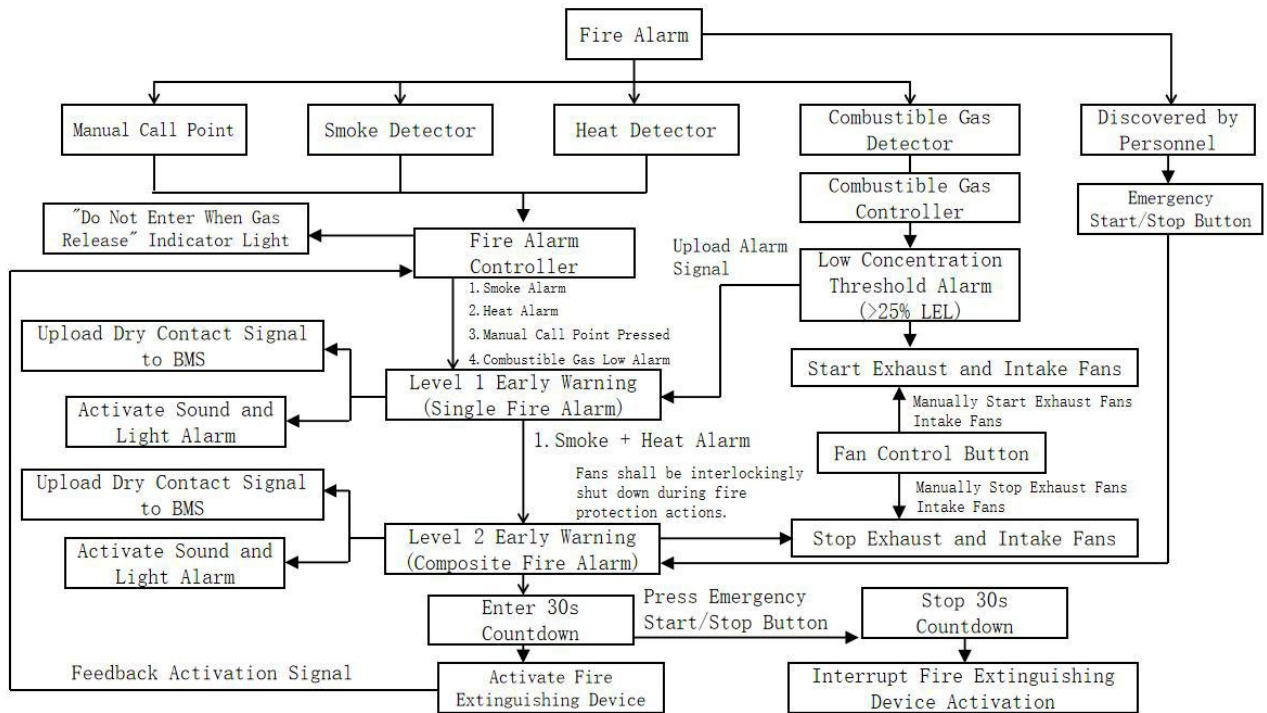
The water immersion system is composed of water immersion transmitters and water immersion sensors. The isolated water immersion detector, based on the change in impedance of the detection electrode after being immersed in water, amplifies, shapes and compares the water immersion input signal through the signal processing circuit, and outputs dry contact or high and low level change signals to indicate whether there is water at the detector's location. The structure adopts an integrated fully sealed plastic shell design, ensuring the high reliability of the product. Full isolation of power input and output is achieved, ensuring high reliability and strong anti-interference ability of the product. This water immersion detector adopts a relay output alarm signal method. When the water immersion detector detects water flooding, it outputs an alarm signal to EMS, which immediately controls the entire energy storage system to stop working.

OLP EC-PV650_P500_E1205-AO01 户外集装箱储能系统用户手册	文件编号: OLPSID-MU-25061601 Document number: OLPSID-MU-25061601	版本:V1.1 Version:V1.1	Page 84 of 106
---	---	-------------------------	----------------

3.8.8. 门禁系统 Access Control System

系统配备门禁系统，门被打开后，用于控制集装箱内的照明灯。

The system is equipped with an access control system. After the door is opened, the light in the container will be on.

4. 安装 Installation

4.1. 安装准备 Installation Preparation

4.1.1. 安装工具 Installation Tools

Clamp meter	Multi-meter	Label paper	Phillips screwdriver
Flat-head screwdriver	Socket wrench	Adjustable wrench	Torque wrench
COAX crimping tool	Diagonal pliers	Wire stripper	Claw hammer
Hammer drill	Insulation tape	Cotton cloth	Brush
Heat shrink tubing	Heat gun	Electrician's knife	Protective gloves
ESD gloves	Insulated gloves	Hydraulic pliers	Cable tie

图 4.1.1-1 安装工具图表

Figure 4.1.1-1 Installation Tools Table



注意安全 Caution!

OLP EC-PV650_P500_E1205-AO01 户外集装箱储能系统用户手册	文件编号: OLPSID-MU-25061601 Document number: OLPSID-MU-25061601	版本: V1.1 Version: V1.1	Page 85 of 106
---	---	---------------------------	----------------

安装工具必须绝缘，避免触电。

The installation tools must be insulated to avoid electric shock.

4.1.2. 安装环境 Installation Environment

储能系统的安装环境应满足以下要求：

The installation environment of energy storage cabinets should meet the following requirements:

- 1) 储能集装箱为户外使用，符合 IP54 防护等级，将设备安装在干燥、无灰尘的环境中。
The energy storage container is an outdoor cabinet that meets the IP54 protection level and is installed in a dry, dust-free environment.
- 2) 场地必须保持良好的通风环境，尽量避免太阳直射，有必要的防火、防水和防鼠、虫处理理。
The venue must maintain a good ventilation environment, avoid direct sunlight as much as possible, and have necessary fire prevention, waterproofing, and rodent and insect prevention measures.
- 3) 场地应远离有毒有害气体集中的区域，远离易燃、易爆、腐蚀性物品。
The site should be kept away from areas where toxic and harmful gases are concentrated, as well as from flammable, explosive, and corrosive materials.
- 4) 场地安装面必须平整干燥，严禁有积水，地面必须高于往年积水最高水平面。
The installation surface of the site must be flat and dry, and there must be no standing water. The ground must be higher than the highest level of standing water in previous years
- 5) 场地地面水平不晃动，并能承载设备的重量，禁止有凹陷或倾斜。
The ground level of the venue should not shake and should be able to bear the weight of the container. It is prohibited to have dents or tilts.
- 6) 储能集装箱前后左右以及上方必须留有足够的空间用于散热、维护和逃生。
Adequate space must be left in front, back, left, right, and above the energy storage container for heat dissipation, maintenance, and evacuation.
- 7) 避免在阴雨或潮湿的天气条件下，打开集装箱门、进行安装。
Avoid opening container doors and installing in rainy or humid weather conditions.
- 8) 温度应在-20℃至+50℃的范围内，以确保储能集装箱保持良好状态工作。
The temperature should be within the range of -20 °C to +50 °C to ensure that the energy storage container operates in good.

4.2. 搬运 Handling



注意安全 Caution!

长途搬运注意事项：

Precautions for long-distance transportation:

- 1) 严禁将本产品与可能对本产品构成影响或损害的设备或物品一起混装运输！
It is strictly prohibited to mix and transport this product with equipment or items that may affect or damage it!

OLP EC-PV650_P500_E1205-AO01 户外集装箱储能系统用户手册	文件编号: OLPSID-MU-25061601 Document number: OLPSID-MU-25061601	版本:V1.1 Version:V1.1	Page 86 of 106
---	---	-------------------------	----------------

**注意安全 Caution!**

吊车吊装注意事项:

Crane Lifting Precautions:

- 1) 需使用吊车试吊，试吊合适后起吊集装箱，再搬运！吊车承重必须满足承重要求。
A crane must be used for a test lift. Once the test lift is satisfactory, lift the container and transport it. The crane's load capacity must meet the load requirements.
在搬运过程中设备斜角需小于 8°，起伏高度尽量低！
During the transportation process, the equipment tilt angle should be less than 8 ° and the height of the undulations should be as low as possible!
- 2) 禁止液压车长距离搬运或走斜坡路！
Do not use hydraulic trucks for long-distance transportation or on sloping roads!
- 3) 起降需轻起轻放，避免冲击或振动，下降时，需要注意安全！
When taking off and landing, handle with care to avoid impact or vibration. When descending, be careful
- 4) 考虑到设备较高，可能会遮挡驾驶员的视线，建议视情况安排人员对驾驶员进行指引！
Considering that the equipment is relatively high and may obstruct the driver's line of sight, it is recommended to arrange personnel to guide the driver according to the situation!
- 5) 在储能集装箱装满电池的场景下，务必留意集装箱的重心点！
In the scenario where the cabinet is filled with batteries, be sure to pay attention to the center of gravity of the cabinet.

OLP EC-PV650_P500_E1205-AO01 户外集装箱储能系统用户手册	文件编号: OLPSID-MU-25061601 Document number: OLPSID-MU-25061601	版本:V1.1 Version:V1.1	Page 87 of 106
©欧力普能源与自动化技术有限公司 2025 保留所有权利 © Olipower Energy & Automation Technologies 2025 All rights reserved.	地址: 深圳市光明区凤凰街道塘尾社区光明大道 380 号尚智科技园 2 栋 A 座 10 楼 Address: 10th Floor, Block A, Building 2, Shangzhi Science and Technology Park, No. 380 Guangming Avenue, Tangwei Community, Fenghuang Street, Guangming District, Shenzhen, China.		Tel: +86 (755) 2650 8686 Website: www.olipower.cn

4.2.1.重心 Center Of Gravity



图 4.2.1-1 重心示意图

Figure 4.2.1-1 Schematic diagram of cabinet center of gravity

4.2.2.搬运方式 Handling Method

- 1) 吊车搬运：吊绑带必须满足整体的称重要求，将绑带绑紧箱体。

Crane handling: A single lifting strap can withstand a weight of no less than 3000KG, and the strap should be tightly tied to the box.



图 4-3 叉车以及吊车搬运示意图

Figure 4-3 Schematic diagram of forklift and crane handling

4.3. 开箱检查 Open Box Inspection

开箱后必须对以下项目进行检查:

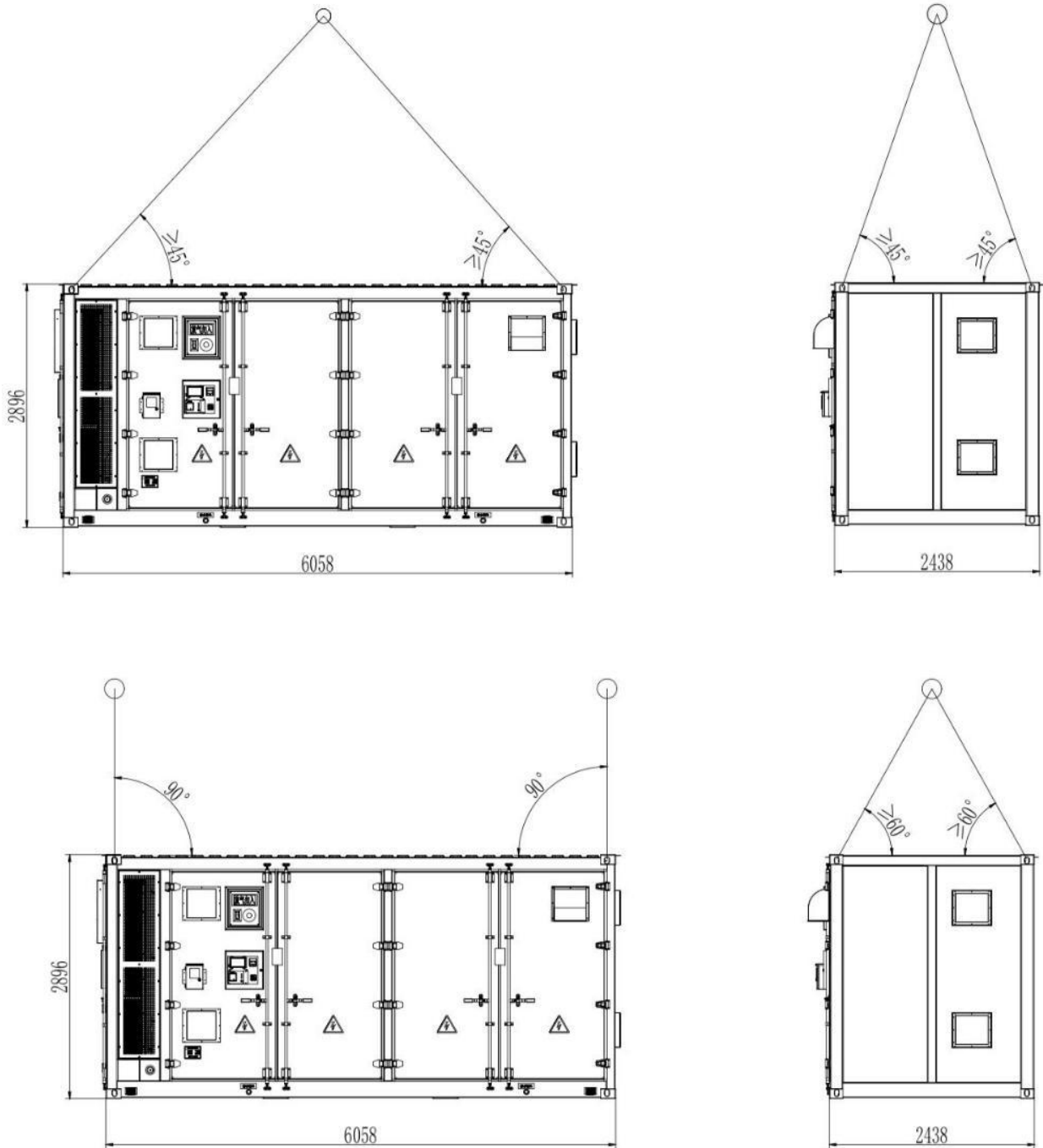
After opening the container, the following items must be inspected:

OLP EC-PV650_P500_E1205-AO01 户外集装箱储能系统用户手册	文件编号: OLPSID-MU-25061601 Document number: OLPSID-MU-25061601	版本:V1.1 Version:V1.1	Page 89 of 106
---	---	-------------------------	----------------

序号 NO.	检查项 Inspection items	确认 Confirm
1	外观无损坏、刮痕、油漆正常 The appearance is undamaged, scratch free, and the paint is normal	
2	产品外包装完好，无破损、受潮、变形 The outer packaging of the product is intact, without damage, moisture, or deformation	
3	设备内部的连接螺栓无松动，部件是否有位移、倾斜 The connecting bolts inside the equipment are not loose, and there is no displacement or tilt of the components	
4	配件包装完整，配件数量和规格正确 The packaging of the accessories is complete, and the quantity and specifications of the accessories are correct	

表 4.3-1 开箱后检查表

Table 4.3-1 Inspection Checklist after Unboxing

4.4. 安装 Installation



注意安全 Caution!

安装注意事项:

Precautions for installation:

- 1) 安装作业时，必须严格遵循安全提示，否则可能导致设备损坏、人身伤害或严重的伤亡事故，请严格遵守安全提示！

When installing, it is necessary to strictly follow the safety instructions, otherwise it may cause equipment damage, personal injury or serious injury accidents. Please strictly follow the safety instructions!

- 2) 安装必须由专业人员在遵循所有警告提示的条件下，正确进行设备安装！

The installation must be carried out correctly by professionals while following all warning prompts!

- 3) 请确保安装位置的机械强度足以支撑设备重量，否则会导致机械危险！

Please ensure that the mechanical strength of the installation location is sufficient to support the weight of the equipment, otherwise it may cause mechanical danger!

- 4) 请勿穿着宽松的衣服或佩戴饰品，并佩戴好防护设备，否则可能会有触电的危险！

Do not wear loose clothing or accessories, and wear protective equipment, or there may be a risk of electric shock!

OLP EC-PV650_P500_E1205-AO01 户外集装箱储能系统用户手册	文件编号: OLPSID-MU-25061601 Document number: OLPSID-MU-25061601	版本:V1.1 Version:V1.1	Page 90 of 106
---	---	-------------------------	----------------

4.4.1. 安装间隙 Installation clearance



图 4.4.1-1 安装间隙示意图(单位 mm)

Figure 4.4.1-1 Schematic diagram of installation gap (unit: mm)

4.4.2. 安装孔位 Installation Hole Position

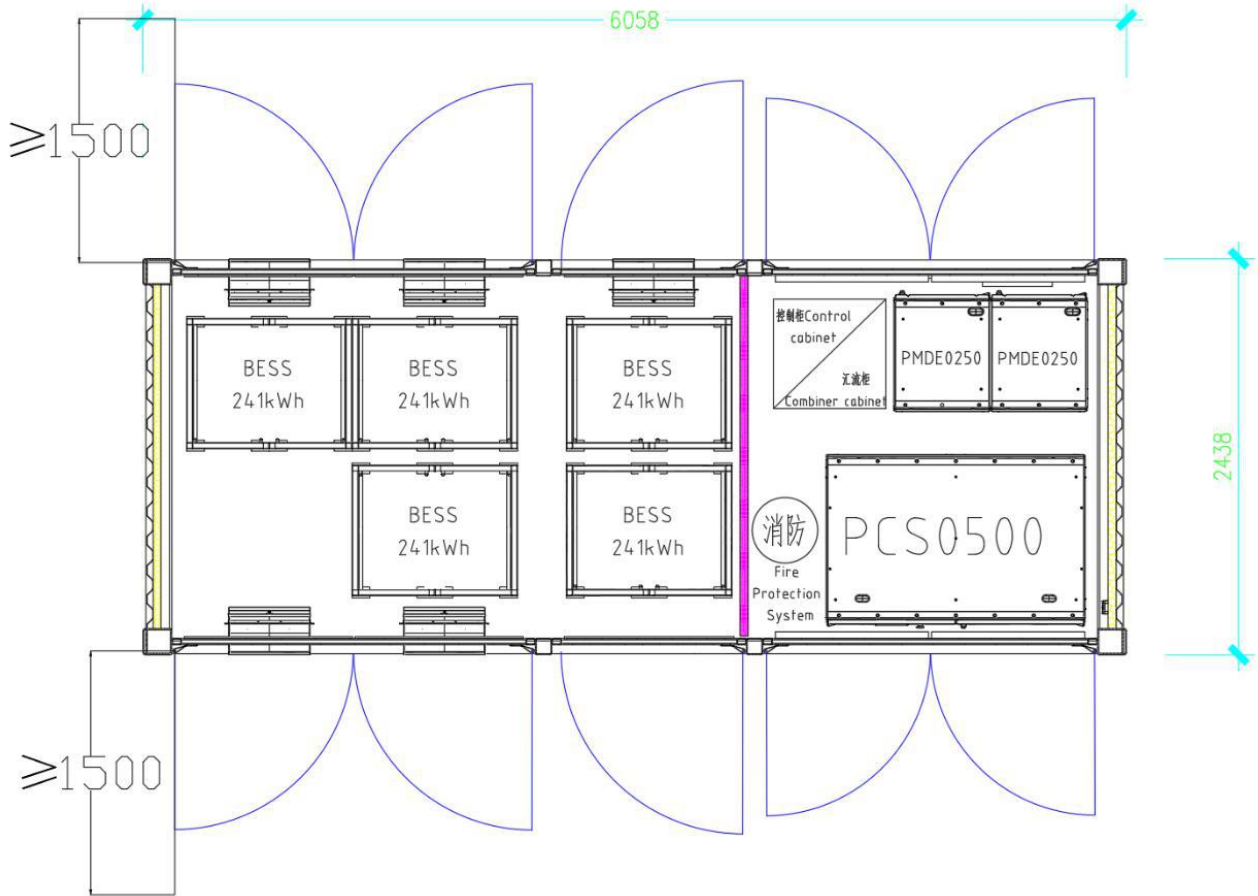

图 4.4.2-1 安装固定孔位尺寸示意图

Figure 4.4.2-1 Schematic diagram of fixed hole size for installation

4.4.3. 地基与勾线 Foundation And Hook Line

- 1) 预埋件下部固定在硬化地面上，上部使用螺栓连接固定设备。
The lower part of the embedded parts is fixed on the hardened ground, and the upper part is connected to the fixed equipment with bolts.
- 2) 穿线钢管分为功率进线管和信号线进线管(预留)。
The threading steel pipe is divided into power inlet pipe and signal inlet pipe (reserved).
- 3) 施工时，应保证设备底部高于当地历史最高水位。
During construction, it should be ensured that the bottom of the equipment is above the local historical highest water level.
- 4) 设备(包含高度、预埋部分、穿线管等)结合工艺和现场调整。
Equipment (including height, pre embedded parts, conduit, etc.) should be adjusted according to the process and on-site conditions.

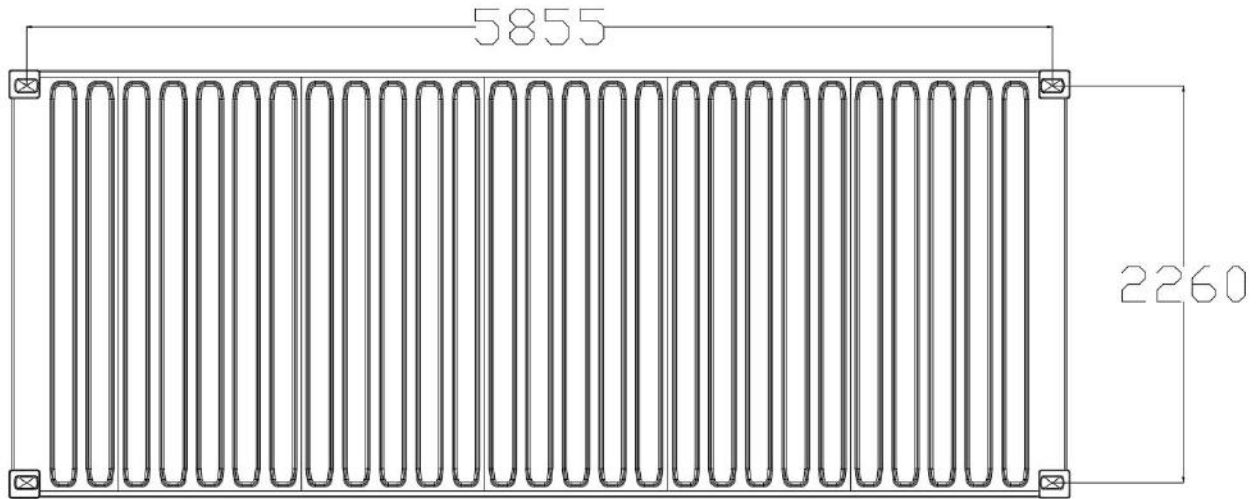
如采用地沟的走线方式，则地沟要求：

If the wiring method of the trench is adopted, the trench requirements are:

- 1) 设备采用下进线的方式，为防止异物进入，侧面未留进线孔。
The equipment adopts a bottom entry method, and to prevent foreign objects from entering, there is no wire hole left on the side of the container.
- 2) 地沟必须有必要的防尘防鼠设计，防止异物进入。
The trench must have necessary dust-proof and rodent proof design to prevent foreign objects from entering.
- 3) 地沟中需要有必要的防水防潮设计，防止线缆老化短路。

OLP EC-PV650_P500_E1205-AO01 户外集装箱储能系统用户手册	文件编号: OLPSID-MU-25061601 Document number: OLPSID-MU-25061601	版本:V1.1 Version:V1.1	Page 92 of 106
---	---	-------------------------	----------------

Necessary waterproof and moisture-proof design is required in the trench to prevent cable aging and short circuit.

- 4) 地沟设计时需要充分考虑到线缆的截面积与弯曲半径。

When designing trenches, it is necessary to fully consider the cross-sectional area and bending radius of cables.



图 4.4.3-1A 地面地基尺寸与要求示意图 正面图

Figure 4.4.3-1A Schematic diagram of ground foundation dimensions and requirements Front

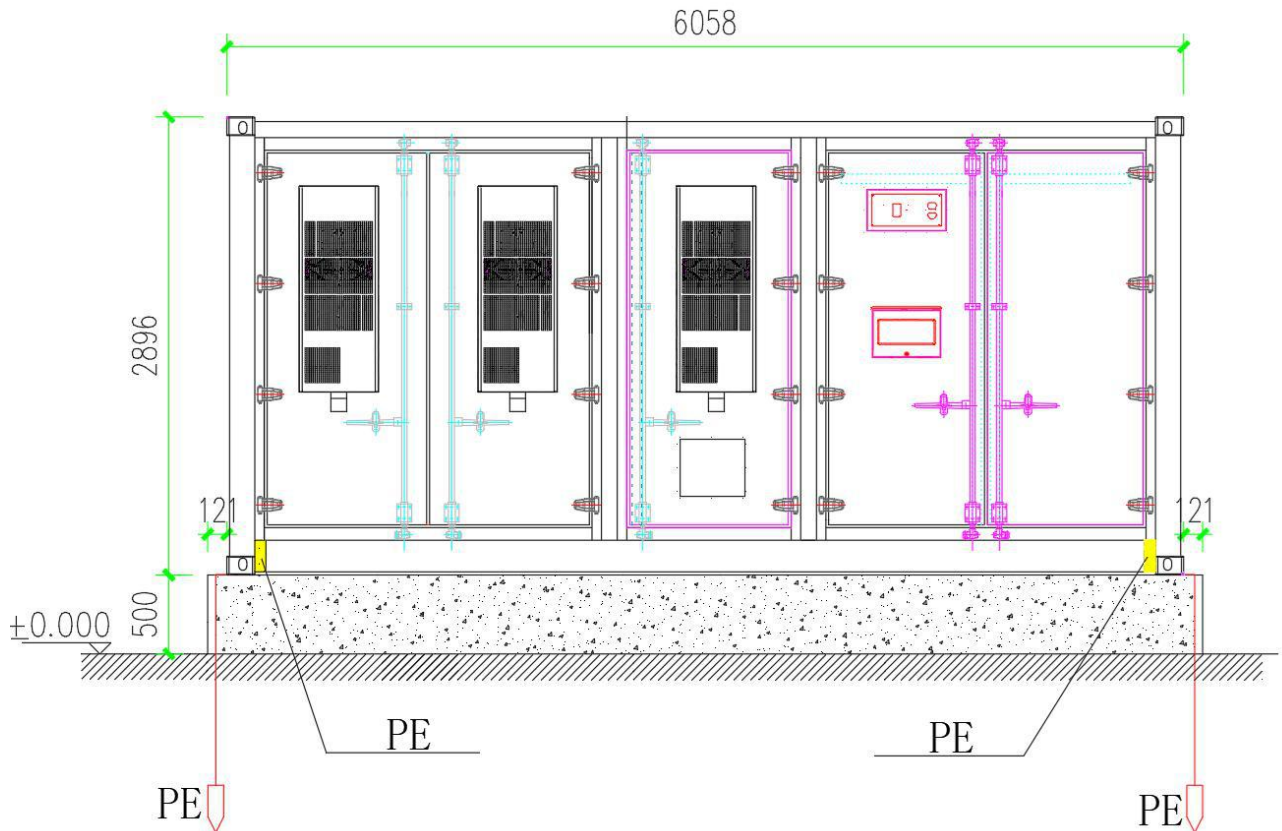

图 4.4.3-2B 地面地基尺寸与要求示意图 侧面

Figure 4.4.3-2B Schematic diagram of ground foundation dimensions and requirements Left

4.4.4. 固定 Fixing

- 1) 确认安装平面上的固定孔位和集装箱的底部安装孔位一致。
Confirm that the fixed holes on the installation plane are consistent with the bottom installation holes of the container.
- 2) 将设备搬运到安装位置。
Move the container to the installation location.
- 3) 对准螺孔，并用螺钉将设备固定在槽钢或地基上，安装扭矩为 300N.m。
Align the screw holes and fix the equipment on the channel steel or foundation screws, with an installation torque of 300N. m.

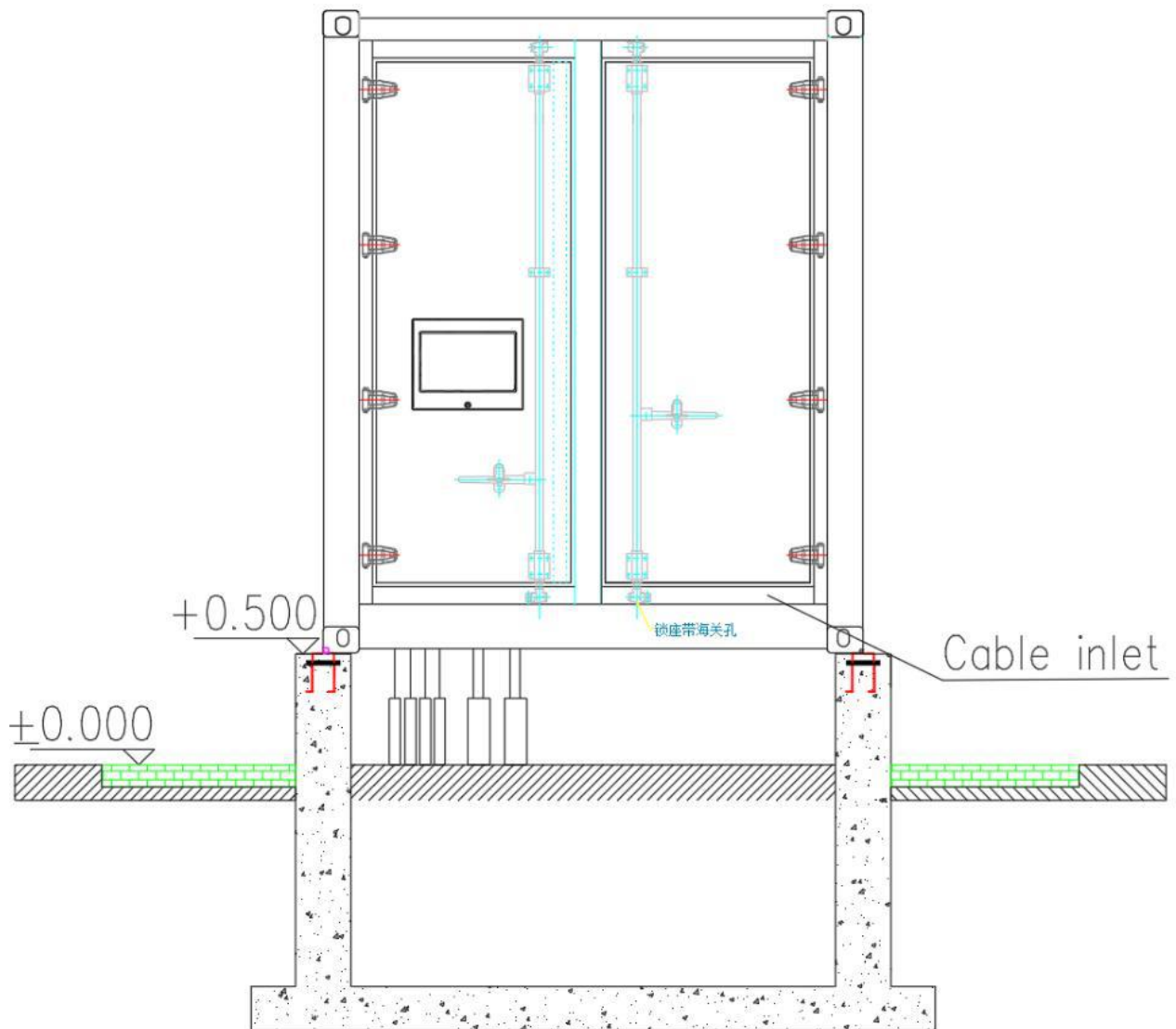
<p>OLP EC-PV650_P500_E1205-AO01 户外集装箱储能系统用户手册</p>	<p>文件编号: OLPSID-MU-25061601 Document number: OLPSID-MU-25061601</p>	<p>版本:V1.1 Version:V1.1</p>	<p>Page 94 of 106</p>
<p>©欧力普能源与自动化技术有限公司 2025 保留所有权利 © Olipower Energy & Automation Technologies 2025 All rights reserved.</p>		<p>地址: 深圳市光明区凤凰街道塘尾社区光明大道 380 号尚智科技园 2 栋 A 座 10 楼 Address: 10th Floor, Block A, Building 2, Shangzhi Science and Technology Park, No. 380 Guangming Avenue, Tangwei Community, Fenghuang Street, Guangming District, Shenzhen, China.</p>	

4.5. 电气安装 Electrical Installation



注意安全 Caution!

电气安装注意事项:

Precautions for Electrical Installation:

为保证安装人员的生命安全，在对本产品进行电气安装时必须有必要的安全防护措施，进行电气安装时，必须遵循以下规程：

To ensure the safety of installation personnel, necessary safety protection measures must be taken during electrical installation of this product. The following regulations must be followed during electrical installation:

- 1) 必须是专业人员才能对设备进行安装，安装过程中严格按照用户手册指导进行！
Professional personnel are required to install the container, strictly following the instructions in the user manual during the installation process!
- 2) 安装人员必须遵守所在国家或地区的相关电气操作规范！
Installation personnel must comply with the relevant electrical operation regulations of the country or region where they are located!
- 3) 不允许在带电状态下安装！
Installation while live is not allowed!
- 4) 安装前，必须将外部的连线断开，确保设备内所有元件都处于无电状态！
Before installation, the external wiring of the container must be disconnected to ensure that all components inside the container are in a dead state!
- 5) 必须在断电位置留警示标志，必要时用锁锁止，以防止在安装过程中被重新上电！
Warning signs must be left at the power-off location, and if necessary, locked with a lock to prevent being re powered on during installation!

4.5.1. 接线检查 Wiring Inspection

接线作业前，确保完成如下检查：

Before wiring operations, ensure that the following checks are completed:

- 1) 接线时使用到的线缆已符合相应的线径和屏蔽等要求。
The cables used for wiring have met the corresponding requirements for wire diameter and shielding.
- 2) 保证设备和产品良好接地。
Ensure good grounding of equipment and products.
- 3) 线的相关选配件已准备就绪。
The relevant accessories for wiring are ready.
- 4) 线缆需要满足电压绝缘等级，有必要的防护，避免线缆绝缘皮有划伤划破的情况。
The cable needs to meet the voltage insulation level and have necessary protection to avoid scratching the insulation skin of the cable.

接线作业后，确保完成如下检查：

OLP EC-PV650_P500_E1205-AO01 户外集装箱储能系统用户手册	文件编号：OLPSID-MU-25061601 Document number: OLPSID-MU-25061601	版本:V1.1 Version:V1.1	Page 95 of 106
---	--	-------------------------	----------------

After the wiring operation, ensure that the following checks are completed:

- 1) 测量进线侧电压是否在规定范围内，确认不存在缺相，短路等故障。
Measure whether the voltage on the incoming side is within the specified range and confirm that there are no faults such as phase loss or short circuit.
- 2) 电源输入端子已经进行正确连接并且牢固可靠。
The power input terminal has been correctly connected and securely fastened.
- 3) 接地线已经可靠接地。
The grounding wire has been reliably grounded.

4.5.2.接线说明 Wiring Instructions

光伏接线: **Photovoltaic wiring:**



图 4.5.2-1A PMDE 与 PCS 接线位置
Figure 4.5.2-1A PMDE and PCS wiring positions

OLP EC-PV650_P500_E1205-AO01 户外集装箱储能系统用户手册	文件编号: OLPSID-MU-25061601 Document number: OLPSID-MU-25061601	版本:V1.1 Version:V1.1	Page 96 of 106
---	---	-------------------------	----------------

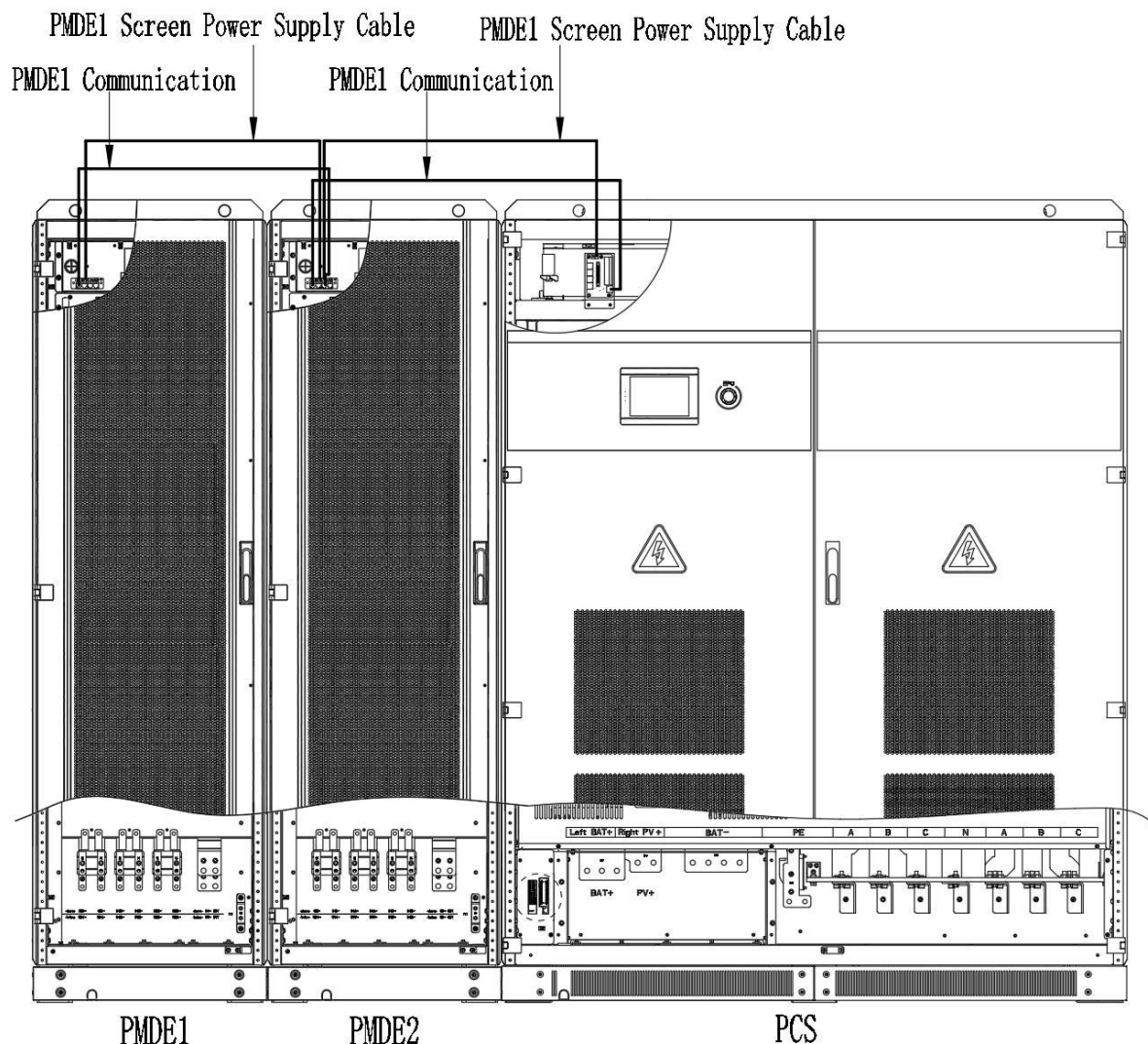

图 4.5.2-2B PMDE 与 PCS 对外接线端子
Figure 4.5.2-2B PMDE and PCS external wiring terminals

5. 调试与运行 Debugging And Operation

5.1. 检查 Inspection

开机运行前需要检查以下项目：

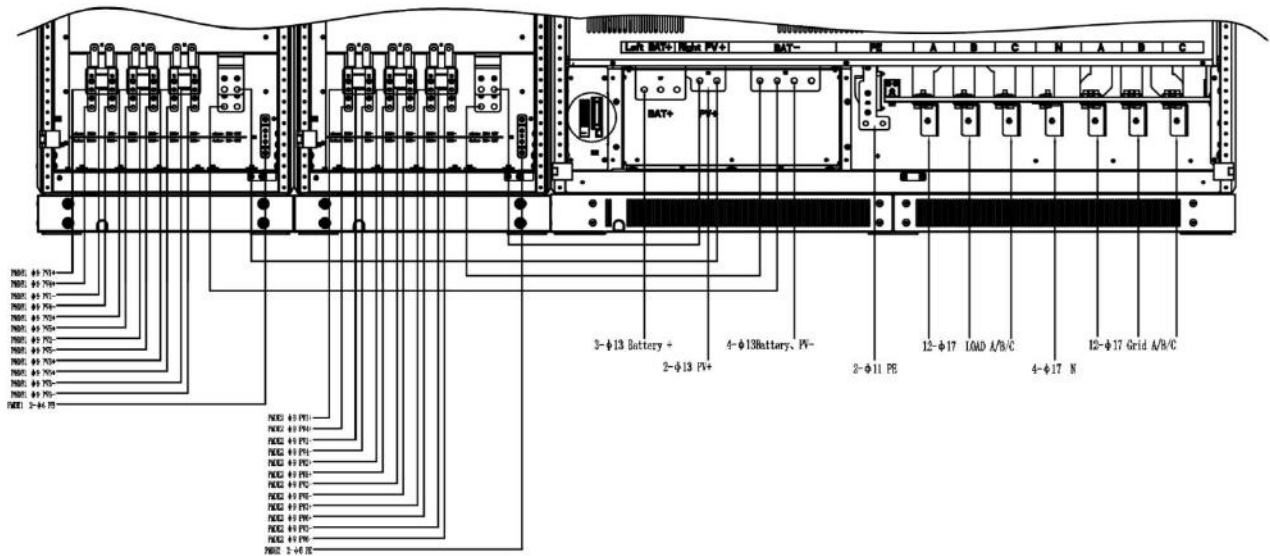
Before starting up and running, the following items need to be checked:

序号 NO.	开机运行前检查项目 Check items before startup and operation
1	检查设备各个部分是否有凝露现象(表面有水膜或水滴产生)。若有，必须打开设备通风，直到现象消失。 Check whether there is condensation phenomenon (water film or water droplets on the surface) in various parts of the container. If there is, the container must be opened for ventilation until the phenomenon disappears.
2	检查设备各个通风口和散热风扇是否有异物阻塞。若有，必须清理干净堵塞风口的异物。 Check if there are any foreign objects blocking the ventilation openings and cooling fans of the container. If there are any foreign objects blocking the air vent, they must be cleaned up.
3	与电网连接侧端子必须正确连接并牢固，确保电压在规定范围内，不存在短路等故障。 The terminal on the side connected to the power grid must be correctly connected and firmly secured to ensure that the voltage is within the specified range and there are no faults such as short circuits.
4	各个控制信号电缆接线正确。 The wiring of each control signal cable is correct.

5	<p>设备内与各个电源回路连接点无异物。(电线头、金属屑等) There are no foreign objects at the connection points between the container and various power circuits. (Wire heads, metal shavings, etc.)</p>
6	<p>设备必须可靠接地。 The container must be reliably grounded.</p>

表 5.1-1 开机运行前检查表
Table 5.1-1 Pre startup Inspection Checklist

5.2. 操作说明 Operating Instructions

5.2.1. 开机 Startup



图 5.2.1-1 高压箱面板指示
Figure 5.2.1-1 High-voltage box panel indicators

在开机前的检查无误后，按顺序执行开机操作：

After confirming the correctness of the pre boot check, perform the boot operation in sequence:

- 1) 确认电缆按要求连接好；
Confirm that the cable has been connected as required;
- 2) 依次闭合 1~5 簇高压控制箱-交流断路器开关 D；
Turn on AC circuit breaker switches (D) on the high voltage control boxes of clusters 1 to 5；
依次闭合 1~5 簇高压控制箱-隔离开关 M，使开关处于“ON”位置；
Turn on switches (M) on the high voltage control boxes for clusters 1 to 5, ensuring they are in the "ON" position;
- 3) 控制柜 UPS 电源 (U01)，选择控制模式，转旁路输出，等待 UPS 上 RUN 灯(绿色)常亮；

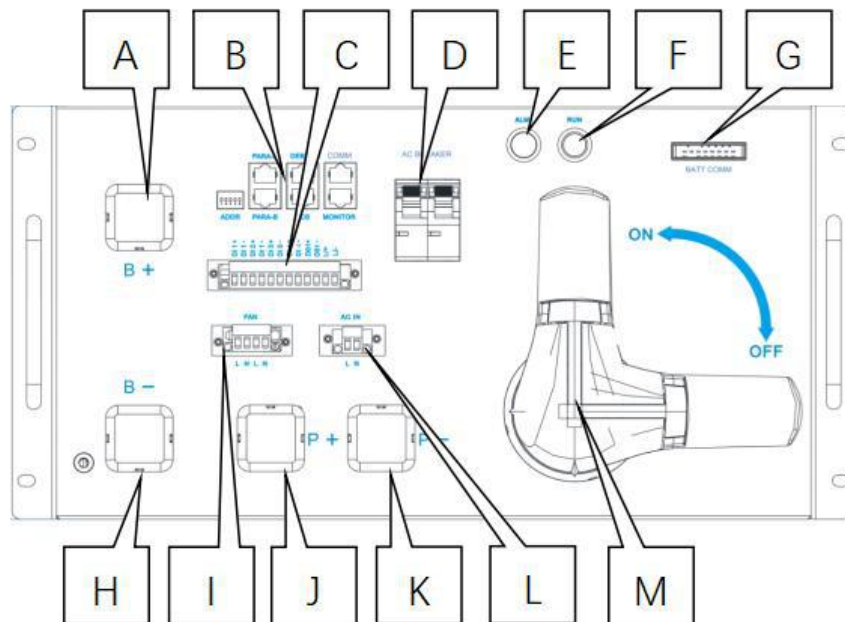
OLP EC-PV650_P500_E1205-AO01 户外集装箱储能系统用户手册	文件编号: OLPSID-MU-25061601 Document number: OLPSID-MU-25061601	版本:V1.1 Version:V1.1	Page 98 of 106
---	---	-------------------------	----------------

- Power on the UPS (U01) for the control cabinet. Select the control mode, switch to bypass output, and wait for the RUN light (green) on the UPS to remain constantly lit;
- 4) 闭合控制柜交流断路器 Q11,Combiner 上电;
Turn on AC circuit breaker Q11 in the control cabinet to power on the Combiner;
 - 5) 闭合控制柜交流断路器 Q10,等待 5 簇高压控制箱上 RUN 灯(绿色)常亮;
Turn on AC circuit breaker Q10 in the control cabinet and wait for the RUN lights (green) on all 5 clusters of high voltage control boxes to remain constantly lit;
 - 6) 闭合汇流柜隔离开关 Q01 至 ON;
Turn on switch Q01 on the combiner cabinet to the ON position;
 - 7) 依次闭合 PCS 仓 PCS 上直流侧开关 QDC、交流侧断路器 QAC1(LOAD)、QAC2(GRID)、KS、KB1、KB2、KB3, 然后关闭柜门;
Turn on the following switches on the PCS in the PCS compartment in sequence: DC side switch QDC, AC side circuit breakers QAC1 (LOAD), QAC2 (GRID), KS, KB1, KB2, KB3. Then close the cabinet door;
 - 8) 等待 Combiner 上 RUN 灯(绿色)常亮, 与 PCS 通讯成功;
Wait for the RUN light (green) on the Combiner to remain constantly lit, indicating successful communication with the PCS;
 - 9) 光伏控制器开机。点击监控左下角的“菜单”→“开关机”→“DCDC 逆变器开启”, 开启后在监控主界面的右下角显示的光伏控制器状态会有“待机”变为“混合逆变器 xMPPT”, 此时光伏控制器正常运行。
Power on the PV controller. Click "Menu" → "Power On/Off" → "Enable DCDC Converter" at the bottom left of the monitor. After activation, the PV controller status displayed at the bottom right of the main monitor screen will change from "Standby" to "Hybrid Inverter xMPPT", indicating normal operation.
 - 10) 混合逆变器开机。点击监控左下角的“菜单”→“开关”→“DCAC 混合逆变器开启”, 开启后会听到直流接触吸合声音, 而后混合逆变器软起, 软起完成后会听到交流接触器吸合声音, 此时在监控主界面的正下角显示的混合逆变器状态会有变为“混合逆变器离网放电”或“混合逆变器并网充电”或“混合逆变器并网放电”。此时混合逆变器正常运行。
Power on the hybrid inverter. Click "Menu" → "Switch" → "Enable DCAC Hybrid Inverter" at the bottom left of the monitor. After activation, you will hear the DC contactor engage, followed by the soft start of the hybrid inverter. After the soft start completes, you will hear the AC contactor engage. The hybrid inverter status displayed at the bottom center of the main monitor screen will change to "Hybrid Inverter Off-Grid Discharging", "Hybrid Inverter Grid-Connected Charging", or "Hybrid Inverter Grid-Connected Discharging", indicating normal operation.
 - 11) 依次闭合控制柜断路器 Q02、Q03、Q04、Q05、Q06、Q07、Q08、Q09;
Close circuit breakers Q02, Q03, Q04, Q05, Q06, Q07, Q08, Q09 in the control cabinet in sequence;
 - 12) 启动消防系统, 闭合消防报警主机、可燃气体主机电源开关;
Start the fire protection system by closing the power switches for the fire alarm panel and combustible gas detection panel;
 - 13) 开机完成。
Startup process completed.

OLP EC-PV650_P500_E1205-AO01 户外集装箱储能系统用户手册	文件编号: OLPSID-MU-25061601 Document number: OLPSID-MU-25061601	版本:V1.1 Version:V1.1	Page 99 of 106
---	---	-------------------------	----------------

5.2.2.关机 Shutdown

确认可以关机后，按顺序执行关机操作：

After confirming that the shutdown is possible, perform the shutdown operation in sequence:

- 1) 确认充放电过程停止；
Ensure the charging/discharging process has stopped;
- 2) 依次断开控制柜断路器 Q02、Q03、Q04、Q05、Q06、Q07、Q08、Q09、Q10、Q11；
Turn off breakers Q02, Q03, Q04, Q05, Q06, Q07, Q08, Q09, Q10, Q11 in the control cabinet in sequence;
- 3) 关闭 UPS 电源（U01）；
Power off the UPS (U01);
- 4) 断开消防报警主机、可燃气体主机电源开关；
Turn off power switches for the fire alarm panel and combustible gas detection panel;
- 5) 依次断开 1~5 簇高压控制箱-交流断路器开关 D；
Turn off AC circuit breaker switches (D) on the high voltage control boxes for clusters 1 through 5 in sequence;
- 6) 依次断开 1~5 簇高压控制箱-隔离开关 M，使开关处于“OFF”位置；
Turn off switches (M) on the high voltage control boxes for clusters 1 through 5 in sequence, ensuring they are in the "OFF" position;
- 7) 断开汇流柜隔离开关 Q01，使开关处于“OFF”位置；
Turn off switch Q01 on the combiner cabinet, ensuring it is in the "OFF" position;
- 8) 光伏控制器的关机。点击监控左下角的“菜单”→“开关”→“DCDC 变流器关闭”，关闭后在监控主界面的右下角显示的光伏控制器状态会有“混合逆变器 xMPPT”变为“待机”。此时光伏控制器停止工作；
Power off the PV controller. Click "Menu" → "Switch" → "Disable DCDC Converter" at the bottom left of the monitor. After deactivation, the PV controller status displayed at the bottom right of the main monitor screen will change from "Hybrid Inverter xMPPT" to "Standby", indicating the PV controller has stopped operating;
- 9) 混合逆变器关机。点击监控左下角“菜单”→“开关”→“DCAC 混合逆变器关闭”，关闭后会听到交流接触器断开声音，此时在监控主界面的正下角显示的混合逆变器状态会有变为“主机 -00 混合逆变器关闭”。此时混合逆变器停止工作；依次断开 1~5 簇高压控制箱-交流断路器开关 D；
Power off the hybrid inverter. Click "Menu" → "Switch" → "Disable DCAC Hybrid Inverter" at the bottom left of the monitor. After deactivation, you will hear the AC contactor disengage. The hybrid inverter status displayed at the bottom center of the main monitor screen will change to "Main Unit -00 Hybrid Inverter Disabled", indicating the hybrid inverter has stopped operating. Then open the AC circuit breaker switches (D) on the high voltage control boxes for clusters 1 through 5 in sequence;
- 10) 手动断开直流侧断路器 QDC、负荷断路器 QAC1(LOAD)，使开关处于“OFF”位置。
Manually turn off DC side circuit breaker QDC and load circuit breaker QAC1 (LOAD), ensuring they are in the "OFF" position.
- 11) 断开 KB1、KB2、KB3、KS 开关；
Turn off switches KB1, KB2, KB3, KS;

Olp EC-PV650_P500_E1205-AO01 户外集装箱储能系统用户手册	文件编号：OLPSID-MU-25061601 Document number: OLPSID-MU-25061601	版本:V1.1 Version:V1.1	Page 100 of 106
---	--	-------------------------	-----------------

- 12) 断开混合逆变器交流侧断路器 QAC2(GRID)，使开关处于“OFF”位置；
Turn off AC side circuit breaker QAC2 (GRID) for the hybrid inverter, ensuring it is in the "OFF" position;
- 13) 关机完成。
Shutdown process completed.

6. 故障处理 Fault Handling



注意安全 Caution!

在自检时请不要拆卸机器部件。

Please do not disassemble machine components during self inspection.

6.1. 故障一览表 Fault List

序号 NO.	故障名称 Fault name	可能原因 Possible reasons	故障处理 Fault handling
1	单体过压故障 Battery cell overvoltage fault	过度充电 Overcharging	停止充电 Stop charging
2	单体欠压故障 Battery cell undervoltage fault	长期不充电 Long term non charging	及时充电 Timely charging
3	总电压过压故障 Battery total voltage overvoltage fault	过度充电 Overcharging	停止充电 Stop charging
4	电池总电压欠压故障 Battery total voltage undervoltage fault	长期不充电 Long term non charging	及时充电 Timely charging
5	电池充电高温故障 High temperature fault during battery charging	空调故障 Air conditioner fault	检查空调供电，检查空调和高压箱之间连接电缆，重启空调 Check the power supply of the air conditioner, check the connecting cable between the air conditioner and the HVbox, and restart the air conditioner
6	电池充电低温故障 Low temperature fault during battery charging	空调故障 Air conditioner fault	检查空调供电，检查空调和高压箱之间连接电缆，重启空调 Check the power supply of the air conditioner, check the connecting

			cable between the air conditioner and the HVbox, and restart the air conditioner
7	电池放电高温故障 High temperature fault during battery discharge	空调故障 Air conditioner fault	检查空调供电，检查空调和高压箱之间连接电缆，重启空调 Check the power supply of the air conditioner, check the connecting cable between the air conditioner and the HVbox, and restart the air conditioner
8	电池放电低温故障 Low temperature fault during battery discharge	空调故障 Air conditioner fault	检查空调供电，检查空调和高压箱之间连接电缆，重启空调 Check the power supply of the air conditioner, check the connecting cable between the air conditioner and the HVbox, and restart the air conditioner
9	电池充电过流故障 Battery charging overcurrent fault	充电电流超过电池最大电流 Charging current exceeds the maximum current of the battery	降低充电功率 Reduce charging power
10	电池放电过流故障 Battery discharge overcurrent fault	放电电流超过电池最大电流 Discharge current exceeds the maximum current of the battery	降低放电功率 Reduce discharge power
11	绝缘低故障 Low insulation fault	未接地或者雨水或液体进入设备 Not grounded & Rainwater or liquids entering the equipment	检查接地回路是否安装正确 Check if the grounding circuit is installed correctly 检查设备是否淋湿 Check if the equipment is wet
12	空调通讯故障 Communication failure of air conditioner	BMS 与空调通讯线断开 The communication line between BMS and Air conditioner is disconnected	检查 BMS 与空调通讯线 Check the communication line between BMS and air conditioner
13	空调故障 Air conditioner malfunction	空调异常发热，异响，外部有明显撞击等现象 Abnormal heating, abnormal noise, and obvious external impact of air conditioner	检查空调供电电源，排查出风口是否堵塞，风扇是否有异物，联系厂家 Check the power supply of the air conditioner, check if the air outlet is blocked, if there are any foreign objects in the fan, and contact the manufacturer

14	消防触发 Fire trigger	温度感应器和烟雾感应器同时触发，灭火装置启动 The Heat Detector and Smoke Detector are triggered simultaneously, and the fire extinguishing device is activated	联系厂家 Contact the manufacturer
15	BMS 通讯故障 BMS communication failure	BMS 通讯线断开 BMS communication line disconnected	检查 BMS 通讯线 Check the BMS communication cable

表 6-1 故障一览表

Table 6-1 Fault List

7. 日常保养与维护 Daily Maintenance

由于环境的温度、湿度、粉尘及振动的影响，会导致储能设备内部的器件老化，有可能引起潜在的故障发生或降低了设备的使用寿命。因此，有必要对储能设备实施日常和定期的维护保养工作。

Due to the influence of temperature, humidity, dust, and vibration in the environment, the components inside the energy storage container may age, which may cause potential failures or reduce the service life of the container. Therefore, it is necessary to carry out daily and regular maintenance work on the energy storage container



注意安全 Caution!

- 需具有专业资格的人员才可以对储能设备进行维护。
- Personnel with professional qualifications are required to maintain the energy storage container.
- 设备中带强电，在开始维护前必须进行必要的安全防范措施。
- The container is equipped with strong electricity, and necessary safety precautions must be taken before starting maintenance.
- 维护前，必须保证电源都已经断开。
- Before maintenance, it is necessary to ensure that all power sources have been disconnected.
- 维护中，必须严格遵循正确的操作规程。
- During maintenance, it is necessary to strictly follow the correct operating procedures.
- 储能设备内部有储能电容，下电后必须等待 20 分钟以上确认变流器内部处于无电状态才可以进行维护。
- There are energy storage capacitors inside the energy storage container. After power off, it is necessary to wait for more than 20 minutes to confirm that the inverter is in a dead state before maintenance can be carried out.
- 电源断开后，需在断开处挂警示标志，防止在维护过程中有人上电。

OLP EC-PV650_P500_E1205-AO01 户外集装箱储能系统用户手册	文件编号: OLPSID-MU-25061601 Document number: OLPSID-MU-25061601	版本:V1.1 Version:V1.1	Page 103 of 106
---	---	-------------------------	-----------------

- After the power is disconnected, a warning sign should be hung at the disconnection location to prevent someone from powering on during maintenance.
- 为避免意外危险，在维护过程中，维护人员应穿戴绝缘防护用品。
- To avoid accidental danger, maintenance personnel should wear insulation protective equipment during the maintenance process.

7.1. 日常检查项目 Daily Inspection Items

日常检查项目按照下列要点实施：

Daily inspection items should be implemented according to the following key points:

序号 NO.	日常检查项目 Daily inspection items
1	需对储能设备的输入、输出电压电流以及运行状态进行实时监控，并定人定点观察，发现工作异常或电压电流异常需及时进行维护。 Real time monitoring of the input, output voltage, current, and operating status of the energy storage container is required, Assign personnel to observe at designated locations, and promptly carry out maintenance if any abnormal work or voltage/current is found.
2	储能设备内部有无异常响声。 Is there any abnormal noise inside the energy storage container.
3	储能集装箱内部有无异味。 Is there any odor inside the energy storage container.
4	检查外观表面无受损，对表面脏污处使用水或酒精清理，对表面油漆受损处进行补漆处理。 Check the exterior surface of the chassis for any damage, clean any dirty areas with water or alcohol, and touch up any damaged paint on the surface.
5	检查每一簇的高压箱的指示灯是否正常，是否有某一簇由于故障断开了与直流母线的连接 heck if the indicator lights of each cluster's high-voltage box are normal, and if any cluster has disconnected from the DC bus due to a fault.

表 7-1 日常检查项目表

Table 7-1 List of Daily Inspection Items

注意：建议每周检查一次

Attention: It is recommended to check once a week

7.2. 定期检查项目 Regular Inspection Items

定期检查主要针对日常检查及日常运行过程中难以检查到的地方：

Regular inspections mainly target areas that are difficult to detect during daily inspections and operations:

序号 NO.	定期检查项目 Regular inspection items
1	检查设备外观无破损、生锈。

	Check the appearance of the energy storage container for any damage or rust.
2	用测温仪器检测设备内部温度无异常。尤其是线缆及线缆连接处的温度； Use a temperature measuring instrument to check the internal temperature of the equipment without any abnormalities. Especially the temperature of cables and cable connections;
3	检查设备周围的通风、环境温度、湿度、灰尘等环境满足要求。 Check that the ventilation, ambient temperature, humidity, dust, and other environmental conditions around the equipment meet the requirements.
4	检查线缆绝缘层老化、破损等现象，若出现需增加相应的绝缘措施或更换线缆。 Check for any signs of aging or damage to the cable insulation layer. If any issues arise, additional insulation measures should be taken or the cable should be replaced.
5	检查接线螺栓处无老化、烧焦的痕迹，并用手晃动，确认处于拧紧的状态。 Check that there are no signs of aging or burning at the wiring bolts, and shake them by hand to confirm that they are tightened.

表 7-2 定期检查项目表

Table 7-2 Regular Inspection Item List

注意：建议每三个月检查一次

Attention: It is recommended to check every three months

8. 设备清单 Equipment List

8.1. 设备清单 Equipment list inside container

序号 No.	条目 Item	说明 Description	数量 QTY
1	集装箱 Container	6058*2438*2896mm(W*D*H)	1
1.1	高压控制箱 HVbox	BMU+高压保护 BMU + High voltage protection	5
1.2	风冷电池包 Air-cooled battery packs	51.2V/16.07kWh	15*5
1.3	热管理系统 Thermal management system	工业空调 Industrial air conditioners	5
1.4	消防系统 Fire Protection system	温度探测器+烟雾探测器+气溶胶灭火装置 Heat detector + Smoke detector + Aerosol fire extinguishing device	1
1.5	门禁开关 Access control	门禁开关 Access detector	1
1.6	指示灯 Indicator light	辅助电源灯+运行灯+故障灯 Auxiliary power light + Run light + Fault light	1

表 8-1 设备清单（单台集装箱）

Olp EC-PV650_P500_E1205-AO01 户外集装箱储能系统用户手册	文件编号: OLPSID-MU-25061601 Document number: OLPSID-MU-25061601	版本:V1.1 Version:V1.1	Page 105 of 106
---	---	-------------------------	-----------------

Table 8-1 Equipment List inside container (Single container)

8.2. 配件清单 Accessories List

序号 NO.	条目 Item	图片 Picture	数量 QTY.	备注 Remarks
1				
2				
3				
4				
5				

表 8-2 配件清单 Table 8-2 Accessories List